



**JUPITER AVIONICS**  
CORPORATION

**JA34-001**

**Universal Radio Adapter**



**Installation and Operating Manual**

**Rev. A**

**Jupiter Avionics Corporation**  
1959 Kirschner Road  
Kelowna BC  
Canada V1Y 4N7  
Tel: 778-478-2232  
Toll-Free: 855-478-2232  
[www.jupiteravionics.com](http://www.jupiteravionics.com)



Copyright 2014 Jupiter Avionics Corp.

All rights reserved

Jupiter Avionics Corporation (JAC) permits a single copy of this manual to be printed or downloaded for the express use of an installing agency. Any such electronic or printed copy of this manual must contain the complete text of this copyright notice. Any unauthorized commercial distribution of this manual is strictly prohibited. Except as described above, no part of this manual may be reproduced, copied, transmitted, disseminated, downloaded, or stored in any storage medium for any purpose without the express prior written consent of JAC.

**IMPORTANT:**

Information in this document is subject to change without notice.

To confirm the current revision status of this manual, visit the JAC website:

[www.jupiteravionics.com](http://www.jupiteravionics.com)

**RECORD OF REVISIONS**

Revision	Rev Date	Description	ECR
A	Nov 2014	Initial release, Serial number 1001 and higher.	2628

Prepared:  MPB	Checked:  	Approved:  
----------------------	------------------	-------------------



## Table of Contents

<b>SECTION 1 - DESCRIPTION</b> .....	<b>1</b>
1.1 System Overview.....	1
1.2 Features Overview.....	1
1.3 Inputs and Outputs .....	1
1.3.1 Inputs .....	1
1.3.2 Outputs .....	1
1.4 Specifications.....	2
1.4.1 Electrical Specifications.....	2
1.4.2 Mechanical Specifications .....	3
1.4.3 Flammability of Materials .....	3
<b>SECTION 2 – INSTALLATION</b> .....	<b>4</b>
2.1 Introduction .....	4
2.2 Continued Airworthiness.....	4
2.3 Unpacking and Inspecting Equipment.....	4
2.3.1 Warranty .....	4
2.4 Installation Procedures .....	4
2.4.1 Cabling and Wiring .....	4
2.4.2 Mechanical Installation .....	5
2.4.3 Post Installation Checks .....	5
2.5 System Operation .....	5
2.5.1 Configuration Operation.....	5
2.5.2 Receive Operation .....	5
2.5.3 Sidetone Operation .....	5
2.5.4 Relay Operation.....	6
2.5.5 Microphone Operation .....	6
2.6 Adjustments and Configuration using ProCS™ .....	6
2.6.1 ProCS™ Setup .....	6
2.6.2 Configurable Settings .....	6
2.6.3 JA34-001 Settings .....	6
2.6.4 Aircraft Audio Systems List.....	8
2.6.5 Non-Aircraft Radios List.....	8
2.6.6 Other Configuration Features .....	8
2.7 Installation Kit .....	8
2.7.1 Recommended Crimp tools .....	8
2.8 Installation Drawings.....	8
<b>SECTION 3 – OPERATION</b> .....	<b>9</b>
3.1 Introduction .....	9
3.2 Operation .....	9
<b>Appendix A - Installation Drawings</b> .....	<b>A1</b>
A1 Introduction .....	A1
A2 Installation Drawings.....	A1
<b>Appendix B - Installation Documents</b> .....	<b>B1</b>
B1 Airworthiness .....	B2
B2 Instructions for Continued Airworthiness .....	B2



## JA34-001 Universal Radio Adapter

### SECTION 1 - DESCRIPTION

#### 1.1 System Overview

The JA34-001 Universal Radio Adapter allows the aircraft audio management system access to a non-aviation radio. The JA34-001 provides fully isolated audio signal paths to and from the radio to allow a noise-free installation. Microphone biasing and artificial sidetone generation are selectable for radios without them.

The JA34-001 is setup on a 'per installation' basis using cable CAB-USB-0002 and the JA99-001 Configuration Cable, or cable CAB-USB-0006, and downloading the system configuration settings from a PC into non-volatile control devices.

#### 1.2 Features Overview

The JA34-001 unit features an industry standard D-Sub connector pin-out to allow easy field upgrades.

All internal settings are quickly adjusted using the proprietary ProCS™ (**P**roduct **C**onfiguration **S**oftware).

Two Configuration ports are provided for configuration loading; one is beside the main connector and one is on the back of the unit.

All audio outputs are balanced.

The JA34-001 provides relay contact keying, artificial sidetone generation and microphone voltage biasing.

#### 1.3 Inputs and Outputs

Refer to the JA34-001 [connector map](#) for the mating connector designators and contact assignments for the input and output signals.

##### 1.3.1 Inputs

Name	Qty	Type
CONFIG DATA TO JA34	1	Data signal
MODE SELECT TO JA34	1	Öã & ^ e Á signal
RECEIVE INPUT	1	Audio signal
MIC INPUT	1	Audio signal
+28 VDC POWER	1	Electrical power input
POWER GROUND	1	Power supply
RELAY KEY INPUT	1	Öã & ^ e Á Ú } æ

##### 1.3.2 Outputs

Name	Qty	Type
CONFIG DATA FROM JA34-001	1	Data signal
RECEIVE OUT	1	Audio signal
MIC OUTPUT	1	Audio signal
RELAY CONTACTS	6	Audio signal



## **1.4 Specifications**

### **1.4.1 Electrical Specifications**

#### Power Input

Nominal voltage	28 Vdc
Maximum voltage	30.3 Vdc
Minimum voltage	22.0 Vdc
Emergency voltage	18.0 Vdc
Input current	0.5 A max

#### **1.4.1.1 Audio Performance**

##### Rated Input Level

Receive audio rated input level	7.75 Vrms $\pm$ 10%
Microphone input level	250 mVrms $\pm$ 10%

##### Rated Output Power

Rated output power	7.75 Vrms $\pm$ 10%
Microphone rated output (150 Ohm mode)	250 mVrms $\pm$ 10%
Microphone rated output (8 Ohm mode)	50 mVrms $\pm$ 10%

##### Audio Frequency Response

Receive output audio frequency response	$\leq$ 3dB from 300 to 6000 Hz
Microphone audio output audio frequency response	$\leq$ 3dB from 300 to 6000 Hz

##### Distortion Characteristics

Audio output distortion at rated power	$\leq$ 10%
--	------------

##### Input Impedance

Microphone input impedance	150 $\Omega$ $\pm$ 10%
Receive Audio input impedance	600 $\Omega$ $\pm$ 10%

##### Output Load

Receive load	600 $\Omega$ $\pm$ 10%
Microphone load (150 Ohm mode)	150 $\Omega$ $\pm$ 10%
Microphone load (8 Ohm mode)	8 $\Omega$ $\pm$ 20%

##### Input to Input Crosstalk Level

Input to Input crosstalk	$\leq$ 60 dB
--------------------------	--------------

##### Audio Noise Level without Signal

Noise level below the rated output	$\geq$ 60 dB
------------------------------------	--------------

#### **1.4.1.2 Audio Performance, Other**

MIC input designed for MIC type	amplified dynamic/electret
MIC input bias voltage	12 Vdc $\pm$ 10%
MIC input circuitry type	differential
RECEIVE AUDIO input circuitry type	Transformer Coupled
RECEIVE output circuitry type	Transformer Coupled
MIC output circuitry type	Transformer Coupled



1.4.1.3 Discrete Signals

RELAY KEY INPUT, active signal level	$\leq +3$ Vdc
RELAY KEY INPUT, inactive signal level	$\geq +10$ Vdc
Relay contacts shall pass	$\leq 1\text{ADC} @ \leq 30\text{V}$ , Resistive Load

1.4.2 Mechanical Specifications

Height	1.27 in [32.3 mm] maximum	
Depth	2.61 in [66.3 mm] maximum	
Width	4.52 in [114.8 mm] maximum	
Weight	0.38 lb [0.17 kg] maximum	
Material	brushed aluminum with conversion coating	
Connectors (3):	J2, J3 J1	Two 4 pole 3.5mm jack One 25-pin D-Sub male V5 locking
Mounting		4 x 10-32 fasteners
Bonding		$\leq 2.5$ m $\Omega$
Installation kit part number		INST-JA34

1.4.3 Flammability of Materials

The JA34-001 complies with the requirements of RTCA/DO-160G Sec 26.3.3 "Flammability", through equivalent flammability testing of materials and the Small Parts Exemption.

## JA34-001 Universal Radio Adapter

### SECTION 2 – INSTALLATION

#### 2.1 Introduction

This section contains unpacking and inspection procedures, installation information, and post-installation checks.

#### 2.2 Continued Airworthiness

Maintenance of the JA34-001 is on condition only. Scheduled inspection and/or periodic maintenance of this unit is not required.

#### 2.3 Unpacking and Inspecting Equipment

Unpack the equipment carefully. Check for shipping damage and report any problems to the relevant carrier. Confirm that the Certificate of Conformance is included. Complete the on-line warranty card from the Jupiter Avionics Corporation (JAC) website – [www.jupiteravionics.com](http://www.jupiteravionics.com).

##### 2.3.1 Warranty

This product manufactured by JAC is warranted to be free of defects in workmanship or performance for 2 years from the date of installation by an approved JAC dealer or agency. This warranty covers the cost of all materials and labour to repair or replace the unit, but does not include the cost of transporting the defective unit to and from JAC or its designated warranty repair centre, or of removing and replacing the defective unit in the aircraft. This warranty does not cover failures due to abuse, misuse, accident, or unauthorized alteration or repairs.

THIS WARRANTY IS VOID IF THE PRODUCT IS NOT INSTALLED BY AN AUTHORIZED JAC DEALER. If the on-line warranty card is not completed, the product will be warranted from the date of manufacture.

Contact JAC for return authorization, and for any questions regarding this warranty and how it applies to your unit(s). JAC is the final arbiter concerning warranty issues.

#### 2.4 Installation Procedures



---

**WARNING: Loud noise can cause hearing damage. Set the headset volume to minimum before conducting tests, and slowly increase the volume to a comfortable listening level.**

---



---

**CAUTION: The power input circuitry of the unit may be damaged if the installation does not conform to the wiring instructions in this manual.**

---

##### 2.4.1 Cabling and Wiring

All wire shall be selected in accordance with the original aircraft manufacturer's maintenance instructions, or AC43.13-1B Change 1, Paragraphs 11-76 through 11-78. Unshielded wire types shall qualify to MIL-W-22759 as specified in AC43.13-1B Change 1, Paragraphs 11-85, 11-86, and listed in Table 11-11. For shielded wire applications, use Tefzel MIL-C-27500 shielded wire with tag ring or equivalent (for shield terminations) to make the most compact and easily terminated interconnect. Follow the Connector Map in Appendix A of this manual.

Allow 3" from the end of the shielded wiring to the shield termination to allow the connector hood to be easily installed. Refer to the Interconnect drawing in Appendix A of this manual for shield termination details. Note that this unit has a 'clamshell' hood that is installed after the wiring is complete.

Maintain wire segregation and route wiring in accordance with the original aircraft manufacturer's maintenance instructions.



Unless otherwise noted, all wiring shall be a minimum of 24 AWG, except power and ground lines, which shall be a minimum of 22 AWG. Refer to the Interconnect drawing for additional specifications. Check that the ground connection is clean and well secured, and that it shares no path with any electrically noisy aircraft accessories such as blowers, turn-and-bank instruments, or similar loads.

## 2.4.2 Mechanical Installation

The JA34-001 can be mounted in any attitude and location with adequate space and sufficient clearance for the connector and wiring harness. It requires no direct cooling.

## 2.4.3 Post Installation Checks

### 2.4.3.1 Voltage/Resistance checks.

Do not attach this unit until the following conditions are met:

- a) Check P1 pin **1** for +28 Vdc power.
- b) Check P1 pin **14** (Power Ground) for continuity to ground (less than 0.5  $\Omega$ ).
- c) Check P1 pin **15** (Chassis Ground) for continuity to ground (less than 0.5  $\Omega$ ).
- d) Check P1 pins **8, 20, 21** and **23** (Output Ground) for continuity to ground (less than 0.5  $\Omega$ ).
- e) Check all pins for shorts to ground or adjacent pins.

### 2.4.3.2 Configuration

Ensure that the JA34-001 contains the correct configuration settings. This may be done at the factory, on the maintenance bench or in the aircraft before the power on checks are performed. Refer to section 2.5.

### 2.4.3.3 Power on Checks.

Power up the aircraft's systems and confirm normal operation of all functions of the JA34-001 (see section 2.4.5).

- a) Begin with only the pilot's headset attached. Confirm radio operation for both receive and transmit. Check the radio selection and inputs. Do not proceed until the radios are functioning correctly.
- b) Unusual buzzes, hums or other background audio are symptomatic of multiple grounds, or noisy external systems such as blowers or pumps sharing wiring with the audio system. If a transmitter fails to key or correctly modulate it is often the result of not connecting all required grounds to the radio or external audio system.
- c) Check that all configurations settings are correct.

When all performance checks are satisfied, complete the necessary regulatory documentation before releasing the aircraft for service. Refer to [Appendix B](#).

## 2.5 System Operation

The JA34-001 is a remote mount unit and has no user accessible controls.

### 2.5.1 Configuration Operation

The JA34-001 accepts commands on the Configuration connector via the configuration cable (JA99-001) and the configuration tool (ProCs™). (See section 2.6 Adjustments and Configuration)

### 2.5.2 Receive Operation

The RECEIVE INPUT is level controlled and summed with the MIC INPUT (Sidetone) and routed to the RECEIVE OUTPUT.

### 2.5.3 Sidetone Operation

The MIC INPUT audio is level controlled and summed with the Receive Audio and routed to the RECEIVE OUTPUT.





### 2.5.4 Relay Operation

The RELAY KEY INPUT selects the connection of both of the relay common contacts to either their normally closed contact or their normally open contact.

### 2.5.5 Microphone Operation

The MIC INPUT audio is level controlled and routed to the MIC OUTPUT.

## 2.6 Adjustments and Configuration using ProCS™

The JA34-001 has no internal mechanical adjustments. Configuration data is sent to the JA34-001 via the programming port input, using the ProCS™ configuration tool and configuration cables (JA99-001 and CAB-USB-0002, or CAB-USB-0006).

For full information on the configuration process, and for installation of ProCS™ on your computer, refer to the [ProCS™ manual](#) on the Jupiter Avionics website.

### 2.6.1 ProCS™ Setup



The JA34-001 menu items 'ProCS Setup' provide Setup drawings showing the cabling arrangement for connecting the JA34-001 to a computer to allow configuration using ProCS™.

### 2.6.2 Configurable Settings

A standard unit is shipped from the factory with all internal adjustments configured to the default levels shown in bold on the JA34-001 Settings page. At installation, it may be desirable to change some of these settings to suit the local operating environment.

The Aircraft Audio Selection and Non-Aircraft Radio Selection choices are made from drop-down boxes as shown. For further information, refer to sections 2.6.3.1 and 2.6.3.3. All input, output, MIC bias information etc. is automatically added to suit the selected radios.

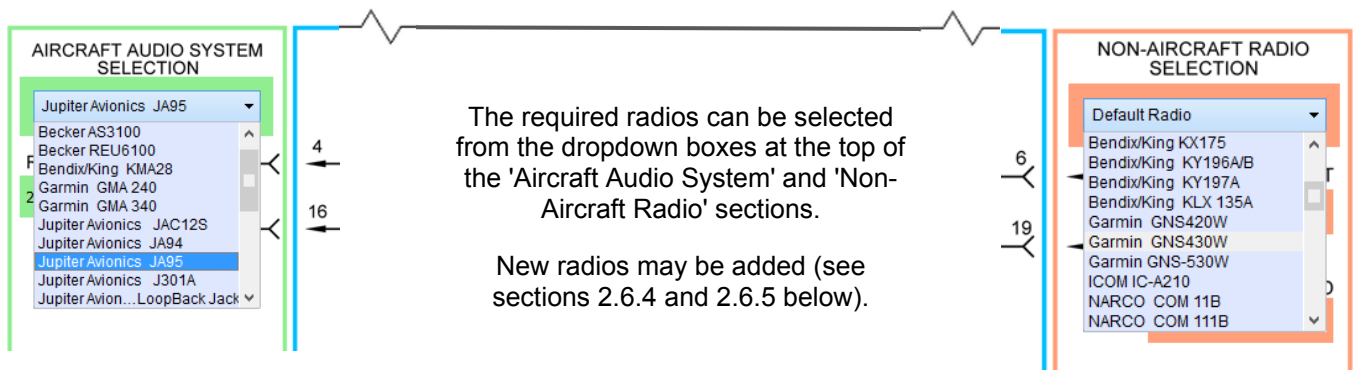

### 2.6.3 JA34-001 Settings

The **Settings** window is divided into three sections: the Aircraft Audio System; the Universal Radio Adapter; and the Non-Aircraft Radio. Each section is colour-coded to keep the relevant information together.

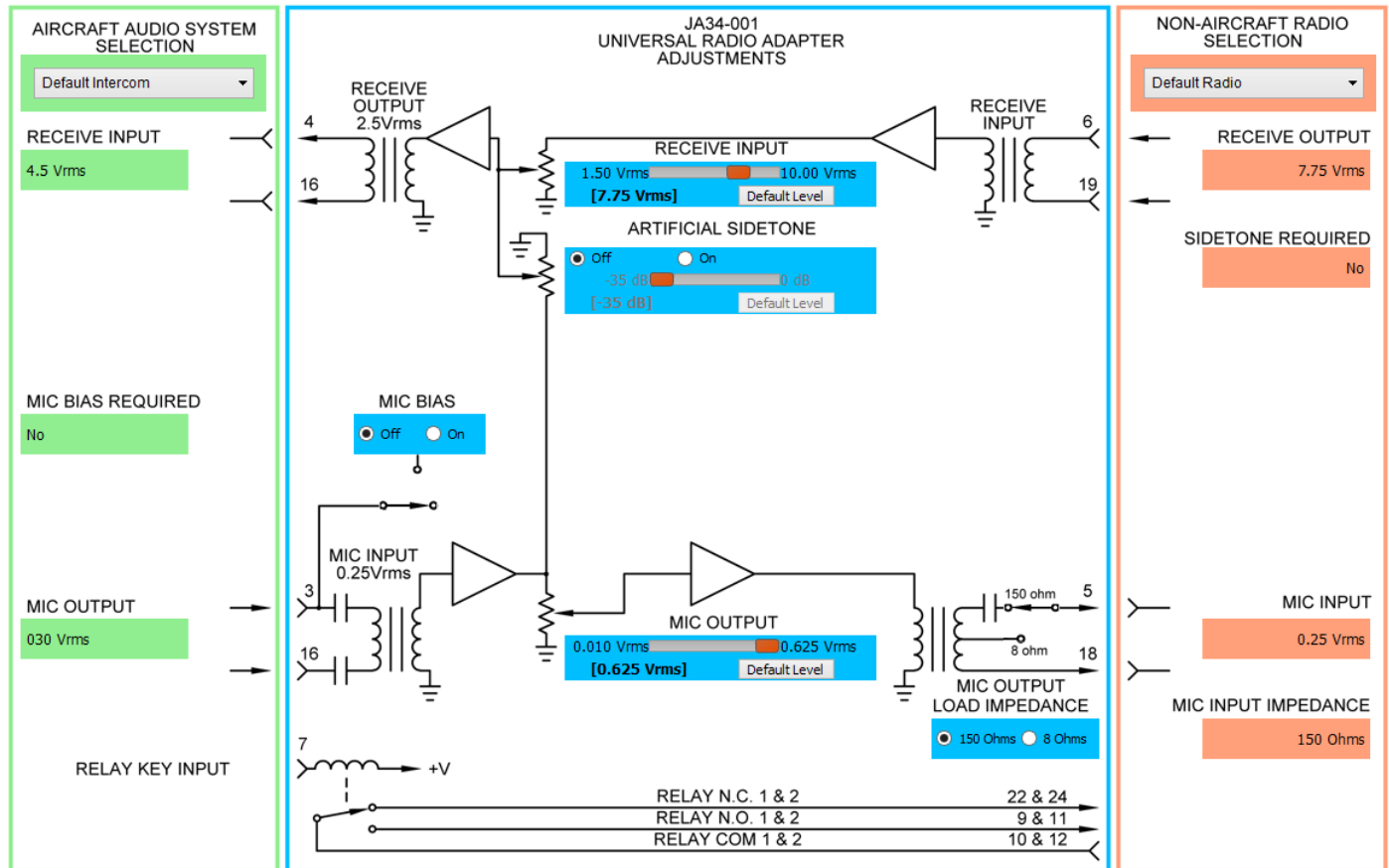

### 2.6.3.1 Aircraft Audio System Selection (Green block)

The appropriate aircraft audio system is selected from a drop-down list at the top of the block, and all relevant configuration information is added automatically. Other aircraft Audio systems can be added to the list (see section 2.5.4).

### 2.6.3.2 JA34-001 Universal Radio Adapter Adjustments (Blue block)

The blue block refers to the adjustments and settings for the JA34-001 Universal Radio Adapter.

#### **Receive Input**

The level of the RECEIVE INPUT can be adjusted from 1.50 to 10.00 Vrms. (Default **7.75 Vrms**)

#### **Artificial Sidetone**

The Artificial Sidetone may be selected as On or Off. When selected ON, the level of the MIC INPUT sidetone may be adjusted from -35 to 0 dB. (Default **-10 dB**) (When Off, the level is -35 dB)

#### **Mic Bias**

The MIC Bias may be On or Off. (Default **On**)

#### **Mic Output**

The level of the MIC OUTPUT signal may be adjusted from 0.010 to 0.625 Vrms. (Default **0.625 Vrms**)

#### **Mic Output Load Impedance**

The MIC OUTPUT impedance may be set to 8 Ohms or 150 Ohms. (Default **150 Ohms**)

### 2.6.3.3 Non-Aircraft Radio Selection (Orange block)

The appropriate Non-Aircraft Radio is selected from a drop-down list at the top of the block, and all relevant configuration information is added automatically. Other Non-Aircraft Radios can be added to the list (see section 2.6.5).



## 2.6.4 Aircraft Audio Systems List

This is a list of Aircraft Audio Systems, and shows the configuration information that will be added to the **JA34-001 Settings** page.

Aircraft Audio Systems List										
Company	Model	Phones Output	Output Desc	MIC Input	MIC Input Description	Receive Input	ive Input Descri	MIC Output	Output Descrip	MIC Bias Required
Default Intercom		4.50 Vrms		0.300 Vrms	300mVrms into 150 Ohms	Vrms	2.5 to 20 Vrms	0.30 Vrms	0.30 Vrms	No
Becker	AS3100	11.00 Vrms	400mW (11...	0.200 Vrms	200mVrms into 150 Ohms	Vrms	6 Vrms	0.15 Vrms	0.15 Vrms	No
Becker	REU6100	8.66 Vrms	250mW (8.6...	0.250 Vrms	250mVrms into 150 Ohms	Vrms	2.5 to 20 Vrms	0.50 Vrms	0.07 to 1.5 Vrms	No
S Engineering	PMA8000B	Vrms	38mW (2.25...	0.250 Vrms	250mVrms into 150 Ohms	Vrms	2.5 Vrms	Vrms	0.25 Vrms	Yes
Technisonic	A710	Vrms	332mW (7V...	0.150 Vrms	150mVrms into 150 Ohms	Vrms	2.5 Vrms	Vrms	0.25 Vrms	Yes
Technisonic	A711	Vrms	332mW (7V...	0.150 Vrms	150mVrms into 150 Ohms	Vrms	2.5 Vrms	Vrms	0.25 Vrms	Yes
Technisonic	A711L	Vrms	332mW (7V...	0.150 Vrms	150mVrms into 150 Ohms	Vrms	2.5 Vrms	Vrms	0.25 Vrms	Yes
Company	New Model	Vrms		Vrms		Vrms		Vrms		No

If it is desirable to add other Audio systems, click on the **Aircraft Audio Systems List**. A new audio system and its parameters can be added by clicking on (the 'New Aircraft Audio System' button). A new line will be added to the bottom of the list, and double clicking on each part of the line will highlight it to allow changes. When the relevant details have been added, use the ('Save Changes') or ('Cancel All Changes') button as required. The added system will then appear on the appropriate drop-down menu list.

## 2.6.5 Non-Aircraft Radios List

This is a list of Non-Aircraft Radios and the configuration information that will be added to the **JA34-001 Settings** page. The list is similar to the Aircraft Audio Systems list, and new radios can be added in the same way.

## 2.6.6 Other Configuration Features

In the JA34-001 Product Information Window, the model number, serial number and check sum of the JA34-001 Universal Radio Adapter can be viewed.

## 2.7 Installation Kit

The kit required to install this unit is not included with the unit.

The installation kit (Part # INST-JA34) consists of the following:

Quantity	Description	JAC Part #
1	TAG ring	CON-5500-0375
1	D-Sub 25-pin connector, hood and 25 crimp pins	CON-3420-0025
1	Heat Shrink Tubing	WIR-HTSK-0750

### 2.7.1 Recommended Crimp tools

Connector Type	Hand crimp tool	Positioner	Insertion/extraction tool
Positronic	9507	9502-3	M81969/1-04
Positronic	AFM8 (Daniels)	M22520/2.08 KB-1	

## 2.8 Installation Drawings

The drawings and documents required for Installation can be found in [Appendix A](#) of this manual.



## JA34-001 Universal Radio Adapter

### SECTION 3 – OPERATION

#### **3.1 Introduction**

The JA34-B001 Universal Radio Adapter allows the aircraft audio management system access to a non-aviation radio.

#### **3.2 Operation**

The JA34-001 is a remote mount unit and has no user accessible controls.



# Installation Manual

## Appendix A - Installation Drawings

### A1 Introduction

The drawings necessary for installation and troubleshooting of the JA34-001 Universal Radio Adapter are in this Appendix, as listed below.

### A2 Installation Drawings

DOCUMENT	Rev
<a href="#">JA34-001 Connector Map</a>	A
<a href="#">JA34-001 Interconnect</a>	A
<a href="#">JA34-001 Mechanical Installation</a>	C

**P1**

25 PIN FEMALE DMIN  
MATING CONNECTOR

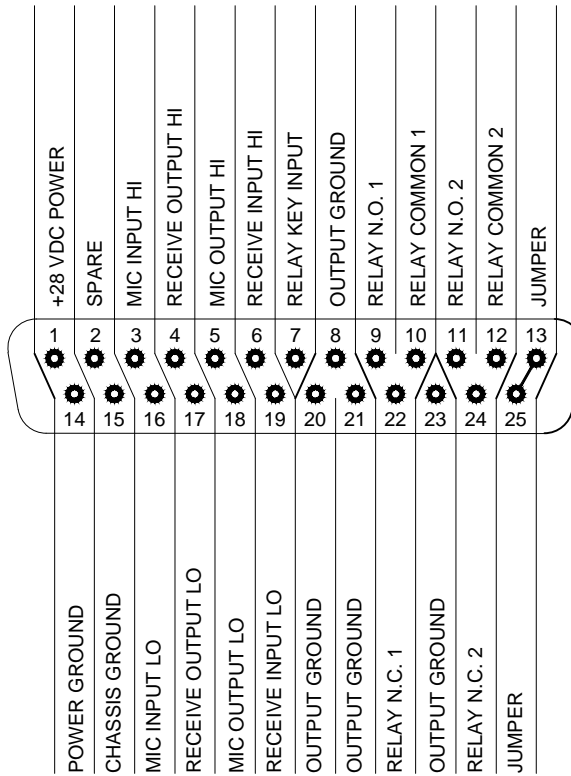

VIEW IS FROM REAR OF MATING CONNECTOR

**CONFIGURATION CONNECTOR**

**P2-P3**

JA99 CONFIGURATION CABLE  
4 POLE MALE 3.5MM STEREO

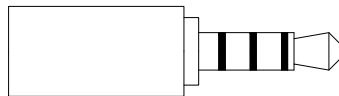



MATING PLUG NAMES

JA34 SIGNAL NAMES

TIP: TX DATA  
1ST RING: RX DATA  
2ND RING: GROUND  
3RD RING: MODE SELECT

CONFIG DATA TO JA34  
CONFIG DATA FROM JA34  
GROUND  
MODE SELECT

PREPARED	TAT			
CHECKED				
APPROVED		NCAGE CODE L00N3	PART NO. JA34-001	SHEET 1/1
CONFIDENTIAL & PROPRIETARY TO JUPITER AVIONICS CORP.		DOC NO. JA34-001 Connector Map Rev A.dwg		

JA34-001 INTERCONNECT WIRING NOTES

NOTES

1. All wire size should be 24 AWG min unless otherwise specified. Unshielded wire should be selected per FAA AC43.13-1B change 1 para 11-76 TO 11-78. Wire types should be in accordance with MIL-W-22759 as described in FAA AC43.13-1B change 1 para 11-85 and 11-86 and listed in table 11-11 or 11-12. All shielded cable should be in accordance with MIL-DTL-27500 (Revision H or later).



△<sub>2</sub> Jumper for a ground to key radio.

△<sub>3</sub> Jumper for a floating contact closure.

△<sub>4</sub> Input/Outputs are transformer coupled (Balanced), 'LO' wires require one termination to ground (usually at the source).

△<sub>5</sub> Connection to airframe ground should be made with 20 AWG wire. Length not to exceed 3 FT (0.9 M).

△<sub>6</sub> Cable shields at the JA34-001 connector pins should be terminated to airframe ground using a tag ring P/N: MS27741-3 or equivalent.

PREPARED	TAT				
CHECKED					TITLE
APPROVED		NCAGE CODE	PART NO.	SHEET	
CONFIDENTIAL & PROPRIETARY TO JUPITER AVIONICS CORP.		L00N3	JA34-001		1/3
		DOC NO.			JA34-001 Interconnect Rev A.dwg

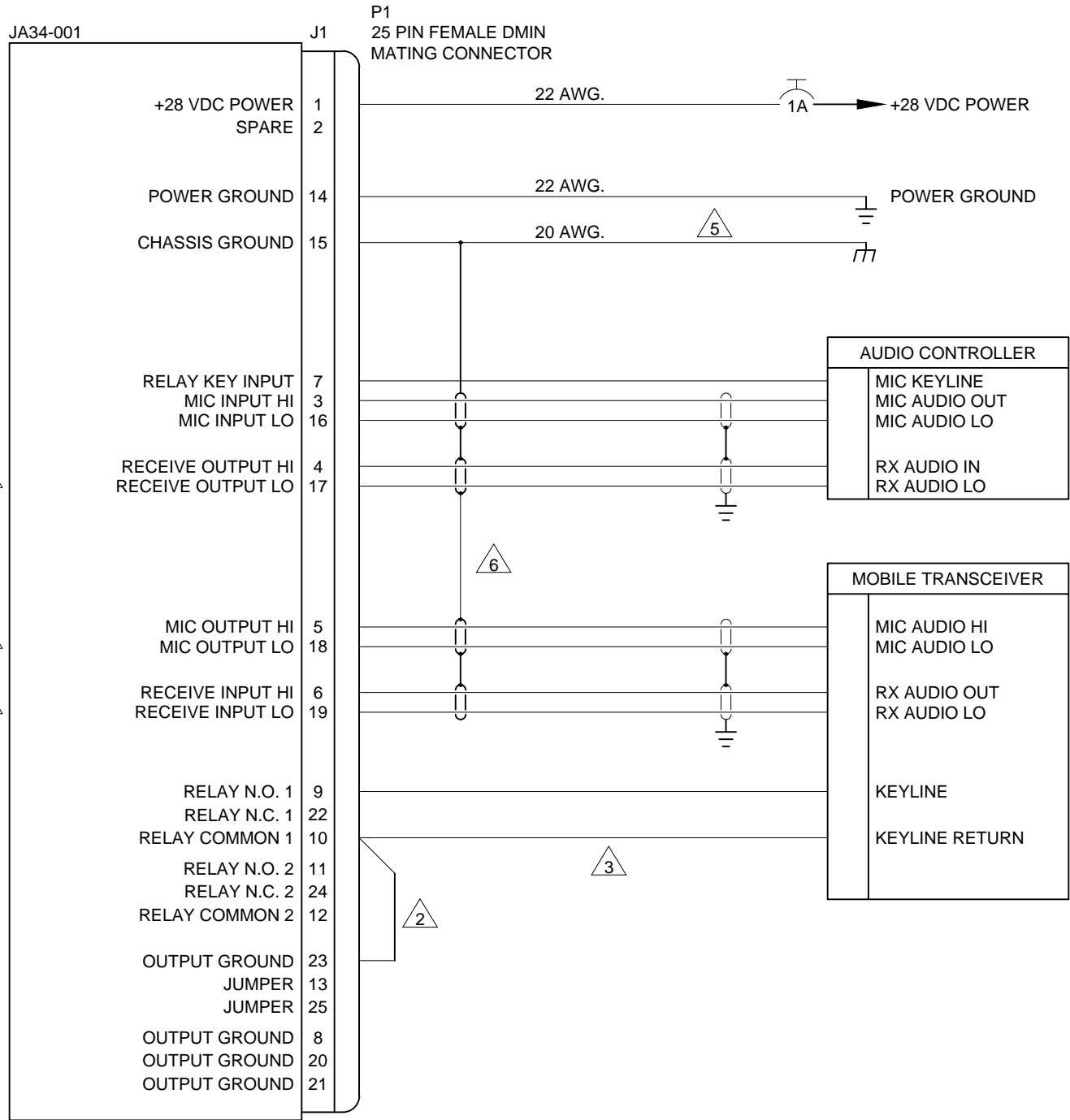





PREPARED	TAT			
CHECKED				
APPROVED		TITLE Universal Radio Adapter		
CONFIDENTIAL & PROPRIETARY TO JUPITER AVIONICS CORP.		NCAGE CODE L00N3	PART NO. JA34-001	SHEET 2/3
		DOC NO. JA34-001 Interconnect Rev A.dwg		



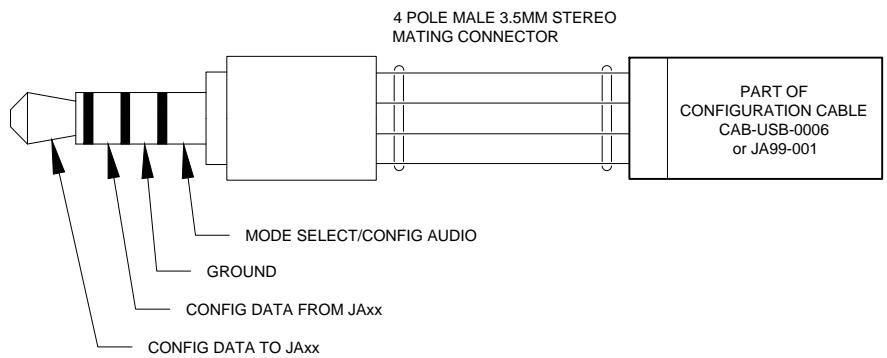
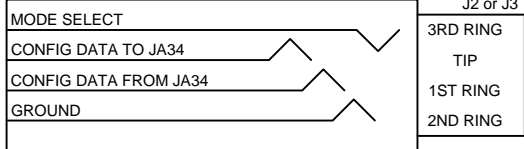

CONFIGURATION CONNECTOR

JA34-001 CONFIGURATION CONNECTOR

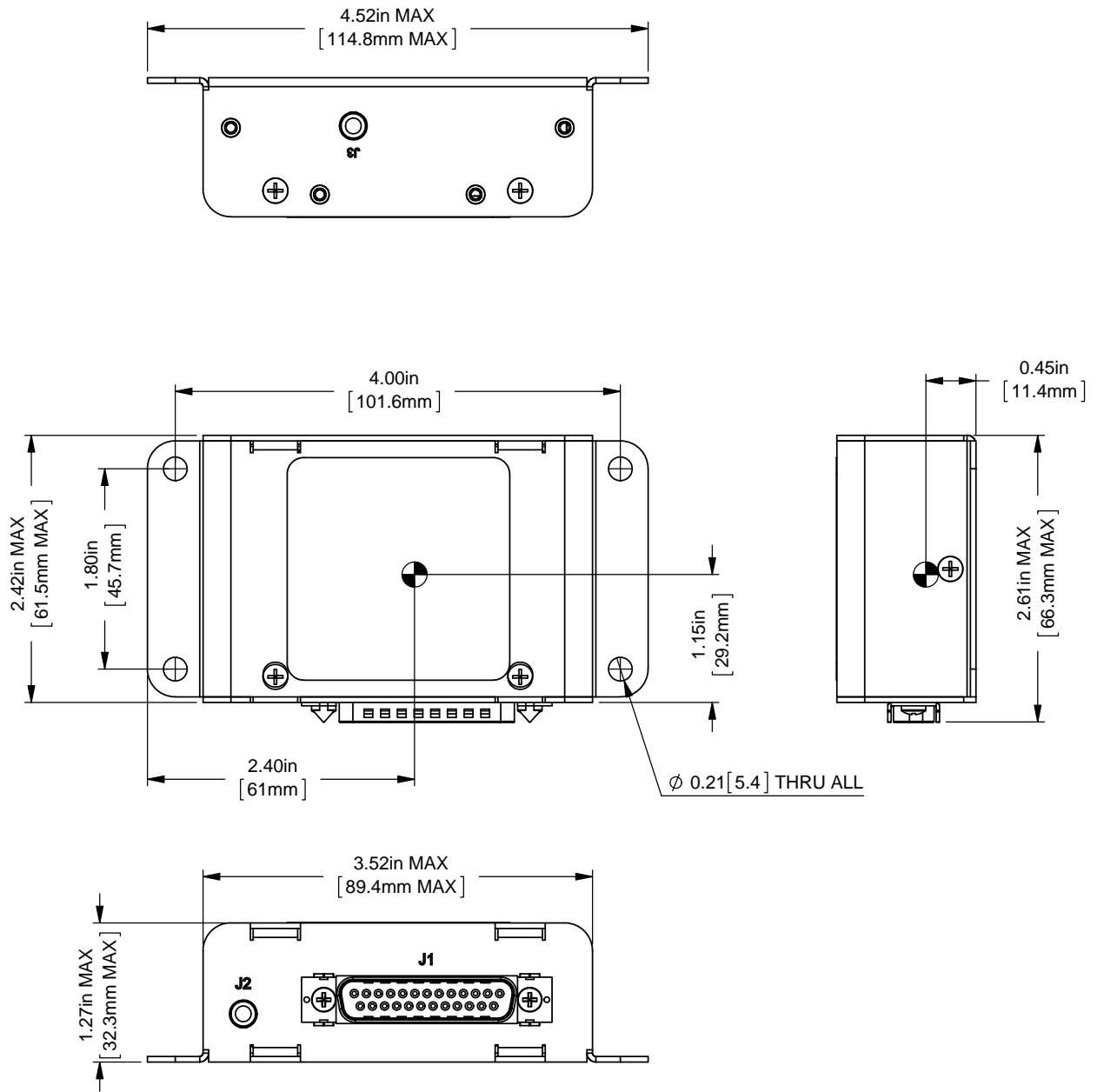

PREPARED	TAT	 <b>JUPITER AVIONICS</b> CORPORATION		TITLE	Universal Radio Adapter J2 and J3 Interconnect
CHECKED					
APPROVED		L00N3	JA34-001	3/3	
CONFIDENTIAL & PROPRIETARY TO JUPITER AVIONICS CORP.		DOC NO. JA34-001 Interconnect Rev A.dwg			



**CENTER OF GRAVITY**  
 ±0.03in [0.8mm]

**WEIGHT: 0.38 lbs [0.17 kg] MAX.**

UNLESS OTHERWISE SPECIFIED  
 DIMENSIONS ARE IN INCHES  
 ANGLES ARE IN DEGREES  
 TOLERANCES:  
 1 DEC PLACE: ± 0.1  
 2 DEC PLACE: ± 0.01  
 3 DEC PLACE: ± 0.005  
 ANGLES: ± 0.5 DEG

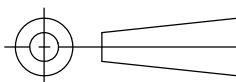

MATERIAL: N/A  
 FINISH: N/A

PREPARED	TAT
CHECKED	
APPROVED	
CONFIDENTIAL & PROPRIETARY TO JUPITER AVIONICS CORP. DRAWING NOT TO SCALE	



**JUPITER AVIONICS**  
CORPORATION

TITLE

Universal Radio Adapter

NCAGE CODE  
L00N3

PART NO.  
JA34-001

SHEET  
1/1

DOC. NO.  
**JA34-001 Mechanical Installation Rev C.SLDDRW**



# **Installation Manual**

## **Appendix B - Installation Documents**



## **B1      Airworthiness**

Airworthiness approval of the JA34-001 requires completion of a TCCA Major Modification Report per CAR STD (AWM) 571 Appendix L, or a FAA Form 337. The sample wording for a description of the work is provided to assist the Installing Agency in preparing Instructions for Continued Airworthiness (ICA) when replacing an existing radio adapter with a Jupiter Avionics JA34-001 Universal Radio Adapter. This sample may be modified appropriately for new installations.

### **Sample Wording:**

Removed the existing [model] radio adapter and replaced with a Jupiter Avionics JA34-001 Universal Radio Adapter in [aircraft location].

Installed in accordance with the JA34-001 Installation Manual, Revision [ ], and AC 43.13-2, Chapters 2, and 3.

The JA34-001 interfaces with existing aircraft radios per the Installation Manual instructions.

The JA34-001 Installation Manual provides detailed installation instructions and wiring diagrams (Section 2, and Appendices A and B).

Power is supplied to the JA34-001 through a 1-Amp circuit breaker.

Aircraft equipment list, weights and balance amended. Compass compensation checked and found to conform to applicable regulations.

## **B2      Instructions for Continued Airworthiness**

Maintenance of the JA34-001 Universal Radio Adapter is “on condition” only. Refer to the JA34-001 Maintenance Manual. Periodic maintenance of the JA34-001 is not required.

The following sample Instructions for Continued Airworthiness (ICA) provides assistance in preparing ICA for the Jupiter Avionics JA34-001 unit installation as part of a Type Certificate (TC) or Supplemental Type Certificate (STC) project to comply with CAR STD (AWM) 523/527/525/529.1529 or FAR 23/25/27/29.1529 “Instructions for Continued Airworthiness”.

Items that may vary by aircraft make and model are shown in brackets (“[ ]”) and should be filled in as appropriate. Some of the checklist items do not apply, in which case they should be marked “N/A” (Not Applicable).

## **Instructions for Continued Airworthiness, Jupiter Avionics JA34-001 Universal Radio Adapter in an [Aircraft Make and Model]**

### **1. Introduction**

[Aircraft that has been altered: Registration number, Make, Model and Serial Number]

**Content, Scope, Purpose and Arrangement:** This document identifies the Instructions for Continued Airworthiness for a Jupiter Avionics JA34-001 installed in an [aircraft make and model].

**Applicability:** Applies to a Jupiter Avionics JA34-001 installed in an [aircraft make and model].

**Definitions/Abbreviations:** None, N/A.

**Precautions:** None, N/A.

**Units of Measurement:** None, N/A.

**Referenced Publications:** JA34-001 Installation Manual

JA34-001 Maintenance Manual

STC/TC # [applicable STC/TC number for the specific aircraft installation]

**Distribution:** This document should be a permanent aircraft record.



## **2. Description of the System/Alteration**

Jupiter Avionics JA34-001 Universal Radio Adapter with interface to external transceivers and [include other equipment/systems as appropriate]. Refer to Appendix A of this manual for interconnect information. Refer to aircraft manufacturer approved interconnect for actual installation.

## **3. Control, Operation Information**

N/A

## **4. Servicing Information**

N/A

## **5. Maintenance Instructions**

Maintenance of the JA34-001 is 'on condition' only. Periodic maintenance is not required. Refer to the JA34-001 Maintenance Manual.

## **6. Troubleshooting Information**

Refer to the JA34-001 Maintenance Manual.

## **7. Removal and Replacement Information**

Refer to Section 2 of this manual - the JA34-001 Installation Manual. If the unit is removed and reinstalled, a functional check of the equipment should be conducted.

## **8. Diagrams**

Refer to Appendix A of this manual - the JA34-001 Installation Manual - for installation drawings and interconnect examples.

## **9. Special Inspection Requirements**

N/A

## **10. Application of Protective Treatments**

N/A

## **11. Data: Relative to Structural Fasteners**

JA34-001 and appropriate mounting hardware installation, removal and replacement should be in accordance with applicable provisions of AC 43.13-1B and AC 43.13-2A.

## **12. Special Tools**

N/A

## **13. This Section is for Commuter Category Aircraft Only**

A. **Electrical loads:** Refer to Section 1 of the JA34-001 Installation Manual.

B. **Methods of balancing flight controls:** N/A.

C. **Identification of primary and secondary structures:** N/A.

D. **Special repair methods applicable to the airplane:** N/A.

## **14. Overhaul Period**

No additional overhaul time limitations.

## **15. Airworthiness Limitation Section**

N/A