



JUPITER AVIONICS
CORPORATION

JA37-001

Aural Message Generator - 3 Channel



Installation and Operating Manual

Rev. C

Jupiter Avionics Corporation
1959 Kirschner Road
Kelowna BC
Canada V1Y 4N7
Tel: +1 778 478 2232
Toll-Free: 1 855 478 2232
www.jupiteravionics.com



Copyright 2014 Jupiter Avionics Corp.

All rights reserved

Jupiter Avionics Corporation (JAC) permits a single copy of this manual to be printed or downloaded for the express use of an installing agency. Any such electronic or printed copy of this manual must contain the complete text of this copyright notice. Any unauthorized commercial distribution of this manual is strictly prohibited. Except as described above, no part of this manual may be reproduced, copied, transmitted, disseminated, downloaded, or stored in any storage medium for any purpose without the express prior written consent of JAC.

IMPORTANT:

Information in this document is subject to change without notice.
To confirm the current revision status of this manual, visit the JAC website:

www.jupiteravionics.com

RECORD OF REVISIONS			
Revision	Rev Date	Description	ECR
A	Jan 2014	Initial release, Serial number 1001 and higher, Pre-TSO	2466
B	Jun 2014	TSO Approved.	2588
C	May 2019	Update message/audio files & RX Input level information	3161



Prepared: MPB	Checked: 	Approved: 
----------------------	-----------------------------------------------------------------------------------------------------	--------------------------------------------------------------------------------------------------------



Table of Contents

SECTION 1 - DESCRIPTION	1
1.1 System Overview	1
1.2 Features Overview	1
1.3 Inputs and Outputs	1
1.3.1 Inputs	1
1.3.2 Outputs	1
1.4 Specifications	2
1.4.1 Electrical Specifications	2
1.4.2 Mechanical Specifications	3
1.4.3 Environmental Specifications	3
1.4.4 Flammability of Materials	3
SECTION 2 – INSTALLATION	4
2.1 Introduction	4
2.2 Continued Airworthiness	4
2.3 Unpacking and Inspecting Equipment	4
2.3.1 Warranty	4
2.4 Installation Procedures	4
2.4.1 Installation Limitations	4
2.4.2 Cabling and Wiring	5
2.4.3 Mechanical Installation	5
2.4.4 Post Installation Checks	5
2.5 System Operation	5
2.5.1 Configuration Operation	5
2.5.2 Message Mute Operation	6
2.5.3 Message Operation	6
2.5.4 Power On Self-Test Operation	6
2.5.5 Priority Operation	6
2.5.6 Non-Priority Operation	6
2.5.7 RX Audio Operation	6
2.6 Adjustments and Configuration using ProCS™	6
2.6.1 ProCS™ Setup	6
2.6.2 Configurable Settings	6
2.6.3 Other Configuration Features	10
2.7 Installation Kit	10
2.7.1 Recommended Crimp tools	10
2.8 Installation Drawings	10
2.8.1 Generation of Custom Drawings	10
SECTION 3 – OPERATION	11
3.1 Introduction	11
3.2 Mute Switch/Button	11



Appendix A - Installation Drawings	A1
A1 Introduction	A1
A2 Installation Drawings.....	A1
Appendix B - Certification Documents	B1
B1 Airworthiness Approval	B2
B2 Instructions for Continued Airworthiness	B2
B3 Environmental Qualification Form	B3



JA37-001 Aural Message Generator - 3 Channel

SECTION 1 - DESCRIPTION

1.1 System Overview

The JA37-001 Aural Message Generator - 3 Channel is a dual channel alerting system that provides up to three different messages.

The JA37 is setup on a per installation basis using cable CAB-USB-0006, or Configuration Cable JA99-001 and CAB-USB-0002, and downloading the system configuration settings and aural messages into non-volatile devices.

1.2 Features Overview

All internal adjustments are quickly adjusted using the proprietary ProCS (Product Configuration Software).

A port is provided beside the main connector for configuration loading.

All audio outputs are balanced.

Each message generator has two separate trigger inputs which may be active low or high dependent on the configuration.

Two isolation amplifiers are provided.

The messages may be muted by an external switch/button.

The JA37-001 is provided with a power on Self-Test.

1.3 Inputs and Outputs

Refer to the JA37-001 connector map for the mating connector designators and pin assignments for the input and output signals.

1.3.1 Inputs

<u>Name</u>	<u>Qty</u>	<u>Type</u>
CONFIG DATA TO JA37-001	1	Data signal
MESSAGE TRIGGER	6	Active High/low discrete (Configurable)
MESSAGE MUTE	1	Active low discrete
POWER INPUT	1	Power supply
RX	2	Audio signal (Configurable)

1.3.2 Outputs

<u>Name</u>	<u>Qty</u>	<u>Type</u>
CONFIG DATA FROM JA37-001	1	Data signal
GROUND	4	Ground reference
PHONES	2	Audio signal
LOW ISOLATION	2	Audio signal
HIGH ISOLATION	2	Audio signal (Configurable)



1.4 Specifications

1.4.1 Electrical Specifications

Power Input

Primary nominal voltage	28 Vdc
Secondary nominal voltage	14 Vdc
Maximum voltage	30.3 Vdc
Minimum voltage	11.0 Vdc
Emergency voltage	9.0 Vdc
Input current	0.5 A max

1.4.1.1 Audio Performance

Rated Input Level

RX audio rated input level	7.75 Vrms $\pm 10\%$
----------------------------	----------------------

Rated Output Level

Phones rated output power into 600 Ohm	7.75 Vrms $\pm 10\%$
Phones low isolation rated output power into 600 Ohm	3.87 Vrms $\pm 10\%$
Phones high isolation rated output power into 600 Ohm	1.94 Vrms $\pm 10\%$

Audio Frequency Response

Phones output audio frequency response	≤ 3 dB from 300 to 6000 Hz
----------------------------------------	---------------------------------

Distortion Characteristics

Phones audio output distortion at rated power	$\leq 10\%$
-----------------------------------------------	-------------

Input Impedance

Receive Audio input Impedance	1000 $\Omega \pm 10\%$
-------------------------------	------------------------

Output Impedance

Phones output Impedance	300 $\Omega \pm 20\%$
Phones low isolation output Impedance	1.2 k $\Omega \pm 20\%$
Phones high isolation output Impedance	3.0 k $\Omega \pm 20\%$

Output Load

Phones load	600 $\Omega \pm 10\%$
-------------	-----------------------

Input to Input Crosstalk Level

Input to Input crosstalk	≤ 60 dB
--------------------------	--------------

Audio Noise Level without Signal

Noise level below the rated output	≥ 60 dB
------------------------------------	--------------

1.4.1.2 Audio Performance, Other

RX input circuitry type	Transformer coupled
Phones output circuitry type	Transformer coupled

1.4.1.3 Discrete Signals

Message Trigger (active low) signal level active	$\leq +3$ Vdc
Message Trigger (active low) signal level inactive	$\geq +6$ Vdc



Message Trigger (active high) signal level active	≥ +8 Vdc
Message Trigger (active high) signal level inactive	≤ +6 Vdc
Message Mute active low signal	≤ +3 Vdc

1.4.2 Mechanical Specifications

Height	1.27 in [32.3 mm] maximum
Depth	4.42 in [112.3 mm] maximum
Width	4.52 in [114.8 mm] maximum
Weight	0.54 lbs [0.24 kg] maximum
Material	brushed aluminum with conversion coating
Connectors (2):	J1 One 25-pin D-Sub male V5 locking J2 One 4 pole 3.5mm jack
Mounting	4 x 10-32 fasteners
Bonding	≤ 2.5 mΩ
Installation kit part number	INST-JA37

1.4.3 Environmental Specifications

The JA37-001 Aural Message Generator - 3 Channel has been tested to the environmental conditions listed below. Environmental categories for which TSO compliance has been demonstrated are listed in the [Environmental Qualification Form](#) in Appendix B of this manual.

Temperature:	
Operating	-45 to +70 °C
Ground Survival	-55 to +85 °C
Altitude	50,000 ft
Humidity	Cat A (48 hours)
Shock, Crash Safety	6 g, 20 g for 11 ms
Vibration	
Fixed Wing - Random and Sinusoidal	Cat. [SBM]
Helicopter - Random, unknown helicopter frequencies	Cat. [U2FF1]

1.4.4 Flammability of Materials

The JA37-001 complies with the requirements of RTCA/DO-160G Sec 26.3.3; Flammability, by design. The JA37-001 has an enclosure constructed of metal, on all sides, and has no vent holes.



SECTION 2 – INSTALLATION

2.1 Introduction

This section contains unpacking and inspection procedures, installation information, and post-installation checks.

2.2 Continued Airworthiness

Maintenance of the JA37-001 is on condition only. Scheduled inspection and/or periodic maintenance of this unit is not required.

2.3 Unpacking and Inspecting Equipment

Unpack the equipment carefully. Check for shipping damage and report any problems to the relevant carrier. Confirm that the Authorized Release Certificate or Certificate of Conformance is included. Complete the on-line warranty card from the Jupiter Avionics Corporation (JAC) website – www.jupiteravionics.com/warranty.

2.3.1 Warranty

This product manufactured by JAC is warranted to be free of defects in workmanship or performance for 2 years from the date of installation by an approved JAC dealer or agency. This warranty covers the cost of all materials and labour to repair or replace the unit, but does not include the cost of transporting the defective unit to and from JAC or its designated warranty repair centre, or of removing and replacing the defective unit in the aircraft. This warranty does not cover failures due to abuse, misuse, accident, or unauthorized alteration or repairs.

THIS WARRANTY IS VOID IF THE PRODUCT IS NOT INSTALLED BY AN AUTHORIZED JAC DEALER. If the on-line warranty card is not completed, the product will be warranted from the date of manufacture.

Contact JAC for return authorization, and for any questions regarding this warranty and how it applies to your unit(s). JAC is the final arbiter concerning warranty issues.

2.4 Installation Procedures



CAUTION: The power input circuitry of the unit may be damaged if the installation does not conform to the wiring instructions in this manual.



WARNING: Loud audio signals may cause hearing damage. Set the message output volume to minimum before conducting listening tests, and slowly increase the output setting to the required level.



WARNING: The messages are intended only to supplement, NOT replace, airframe messages such as 'low rotor RPM', 'engine out' or 'decision height alerting'. The message audio feature is intended for use as a secondary alerting system where another device provides the primary annunciation.

2.4.1 Installation Limitations

The conditions and tests for CAN TSO and FAA TSO approval of the JA37 are minimum performance standards. Those installing the JA37, on or in a specific type or class of aircraft, must determine that the aircraft installation conditions are within TSO standards. The JA37 may be installed only by following the applicable airworthiness requirements.



2.4.2 Cabling and Wiring

All wire shall be selected in accordance with the original aircraft manufacturer's maintenance instructions, or AC43.13-1B Change 1, Paragraphs 11-76 through 11-78. Unshielded wire types shall qualify to MIL-W-22759 as specified in AC43.13-1B Change 1, Paragraphs 11-85, 11-86, and listed in Table 11-11. For shielded wire applications, use Tefzel MIL-C-27500 shielded wire with tag ring or equivalent (for shield terminations) to make the most compact and easily terminated interconnect. Follow the Connector Map in Appendix A of this manual.

Allow 3" from the end of the shielded wiring to the shield termination to allow the connector hood to be easily installed. Refer to the Interconnect drawing in Appendix A of this manual for shield termination details. Note that this unit has a 'clamshell' hood that is installed after the wiring is complete.

Maintain wire segregation and route wiring in accordance with the original aircraft manufacturer's maintenance instructions.

Unless otherwise noted, all wiring shall be a minimum of 24 AWG, except power and ground lines, which shall be in accordance with the Interconnect drawing. Refer to the Interconnect drawing for additional specifications. Check that the ground connection is clean and well secured, and that it shares no path with any electrically noisy aircraft accessories such as blowers, turn-and-bank instruments, or similar loads.

2.4.3 Mechanical Installation

The JA37-001 can be mounted in any attitude and location with adequate space for the front panel and sufficient clearance for the connector and wiring harness. It requires no direct cooling.

2.4.4 Post Installation Checks

2.4.4.1 Voltage/Resistance checks.

Do not attach this unit until the following conditions are met:

- a) Check P1 pin 1 for +28 Vdc or +14 Vdc relative to ground.
- b) Check P1 pin 14 for continuity to ground (less than 0.5 Ω).
- c) Check all pins for shorts to ground or adjacent pins.

2.4.4.2 Configuration

Ensure that the JA37-001 contains the correct configuration settings. This may be done at the factory, on the maintenance bench or in the aircraft before the power on checks are performed. Refer to section 2.5.1.

2.4.4.3 Power on Checks.

Power up the aircraft's systems and confirm normal operation of all functions of the JA37-001.

- a) Check that all configurations settings are correct.

When all performance checks are satisfied, complete the necessary regulatory documentation before releasing the aircraft for service. Refer to [Appendix B](#).

2.5 System Operation

Many of the System Operation parameters are configured using ProCS™ (see [section 2.6](#)).

2.5.1 Configuration Operation

The JA37-001 accepts configuration commands on the Configuration connector via the configuration cable(s) and the configuration tool (ProCS™) - refer to section 2.6.



2.5.2 Message Mute Operation

The JA37-001 stops playing all messages if the MESSAGE MUTE input is activated while any MESSAGE TRIGGER input is active (or when Power On Self-Test is occurring) and stays muted until the next message trigger event.

2.5.3 Message Operation

The JA37-001 Message 1, Message 2 and Message 3 audio signal playback mode are individually selectable between Continual and One-Shot. Message playback may also be configured for Priority operation, see section 2.5.5 – [Priority Operation](#).

When a message is configured as One Shot, the Message audio signal is routed to the phones output and when the corresponding Message Trigger is active. When a message is configured as Continual, the Message audio signal is routed to the phones output for the duration of the trigger input being active.

2.5.4 Power On Self-Test Operation

When the JA37-001 power is off and then POWER INPUT is applied, the three messages will play in the following order: message 1; message 2; message 3. The Power On Self-Test messages may be muted at any time using the MESSAGE MUTE input. See section 2.5.2.

2.5.5 Priority Operation

When Message Trigger Priority is selected (see [Message Trigger Priority](#) in section 2.6.2.1), if more than one trigger is active, the messages will have the following priority: message 1; message 2; message 3. Note that if a higher priority message has been triggered and is set as continual, the lower priority messages will not play until the higher priority trigger is no longer active.

2.5.6 Non-Priority Operation

When Message Trigger Priority is not selected ('Equal Priority' in ProCS™) if more than one trigger is active, the messages will play simultaneously (both Continual and One-Shot messages).

2.5.7 RX Audio Operation

The RX 1 and 2 audio is level controlled and summed with the Message audio and routed to the Phones 1 and 2, Low Isolation 1 and 2 outputs.

2.6 Adjustments and Configuration using ProCS™

The JA37-001 has no internal mechanical adjustments. Configuration data is sent to the JA37-001 via the configuration port (J2), using the ProCS™ configuration tool and configuration cables (JA99-001 and CAB-USB-0002, or CAB-USB-0006).

Product Configuration Software (ProCS™) is available to enable the installer to configure all the necessary level settings and options into the Jupiter Avionics Corporation (JAC) device.

For full information on the configuration process, and for installation of ProCS™ on your computer, refer to the ProCS™ manual on the Jupiter Avionics website - www.jupiteravionics.com/productsoftware.

2.6.1 ProCS™ Setup



The JA37-001 menu item 'ProCS Setup' provides Setup drawings showing the cabling arrangement for connecting the JA37-001 to a computer to allow configuration using ProCS™.

2.6.2 Configurable Settings

A standard unit is shipped from the factory with all internal adjustments configured to the default levels (shown in bold). At installation, it may be desirable to change some of these settings to suit the aircraft operating requirements.



Within ProCS™, the configurable settings for the JA37-001 are grouped together into the following sections:

2.6.2.1 JA37-001 Configurable Pins Function Select

Several of the connector pins can be configured to meet the requirements of specific installations. Refer to JA37-001 Interconnect.

JA37-001 Configurable Pins Function Select		
J1 Contacts Selection		
Pin 10/22:	<input checked="" type="radio"/> HIGH ISOLATION 1 OUTPUT	<input type="radio"/> RX 1 INPUT
Pin 13/25:	<input checked="" type="radio"/> HIGH ISOLATION 2 OUTPUT	<input type="radio"/> RX 2 INPUT

The message trigger activation can be selected as **Active Hi**, or Active Lo.

Message Trigger Activation Type			
Pin 2: MESSAGE 1 TRIGGER A	<input checked="" type="radio"/> ACTIVE LO	<input type="radio"/> ACTIVE HI	EQUAL PRIORITY
Pin 3: MESSAGE 1 TRIGGER B	<input checked="" type="radio"/> ACTIVE LO	<input type="radio"/> ACTIVE HI	EQUAL PRIORITY
Pin 4: MESSAGE 2 TRIGGER A	<input checked="" type="radio"/> ACTIVE LO	<input type="radio"/> ACTIVE HI	EQUAL PRIORITY
Pin 5: MESSAGE 2 TRIGGER B	<input checked="" type="radio"/> ACTIVE LO	<input type="radio"/> ACTIVE HI	EQUAL PRIORITY
Pin 6: MESSAGE 3 TRIGGER A	<input checked="" type="radio"/> ACTIVE LO	<input type="radio"/> ACTIVE HI	EQUAL PRIORITY
Pin 7: MESSAGE 3 TRIGGER B	<input checked="" type="radio"/> ACTIVE LO	<input type="radio"/> ACTIVE HI	EQUAL PRIORITY
<input type="checkbox"/> Message Trigger Priority			

If the 'Message Trigger Priority' box is checked, the signal Priority will be shown.

Message Trigger Activation Type			
Pin 2: MESSAGE1 TRIGGER1	<input checked="" type="radio"/> ACTIVE LO	<input type="radio"/> ACTIVE HI	PRIORITY 1
Pin 3: MESSAGE1 TRIGGER2	<input checked="" type="radio"/> ACTIVE LO	<input type="radio"/> ACTIVE HI	PRIORITY 1
Pin 4: MESSAGE2 TRIGGER1	<input checked="" type="radio"/> ACTIVE LO	<input type="radio"/> ACTIVE HI	PRIORITY 2
Pin 5: MESSAGE2 TRIGGER2	<input checked="" type="radio"/> ACTIVE LO	<input type="radio"/> ACTIVE HI	PRIORITY 2
Pin 6: MESSAGE3 TRIGGER1	<input checked="" type="radio"/> ACTIVE LO	<input type="radio"/> ACTIVE HI	PRIORITY 3
Pin 7: MESSAGE3 TRIGGER2	<input checked="" type="radio"/> ACTIVE LO	<input type="radio"/> ACTIVE HI	PRIORITY 3
<input checked="" type="checkbox"/> Message Trigger Priority			



Message Playback Type		
Message 1:	<input checked="" type="radio"/> CONTINUAL	<input type="radio"/> ONE-SHOT
Message 2:	<input checked="" type="radio"/> CONTINUAL	<input type="radio"/> ONE-SHOT
Message 3:	<input checked="" type="radio"/> CONTINUAL	<input type="radio"/> ONE-SHOT

The message Playback may be selected as '**Continual**' or 'One-Shot' for each message (1 through 3).

2.6.2.2 JA37-001 Messages

JA37-001 Messages		
Audio Files		
Message 1 (11s max):	<input type="text" value="C:/Program Files (x86)/Jac/ProCs/alerts/Alert_sample.wav"/>	<input type="button" value="Open..."/> <input type="button" value="Clear"/> <input type="button" value="▶"/>
Message 2 (11s max):	<input type="text"/>	<input type="button" value="Open..."/> <input type="button" value="Clear"/>
Message 3 (11s max):	<input type="text"/>	<input type="button" value="Open..."/> <input type="button" value="Clear"/>

Audio Files

The JA37-001 is loaded with standard audio signals for each of the three messages, but the audio files window allows these signals to be replaced with other recordings during the configuration process. Selecting 'Open...' will open to the Jac>ProCS folders on the attached computer, but will also allow browsing of any directory accessible from the computer, and any suitable uploaded WAV file. If a new audio file is selected, it may be played using the arrow to the right of the Message line. See 'Saving new Audio files' below.

Phones 1 Message Levels				
0dB = Rated Phones Output				
Message 1:	-42.5 dB	<input type="range"/>	0 dB	[-20 dB] <input type="button" value="Default Level"/>
Message 2:	-42.5 dB	<input type="range"/>	0 dB	[-20 dB] <input type="button" value="Default Level"/>
Message 3:	-42.5 dB	<input type="range"/>	0 dB	[-20 dB] <input type="button" value="Default Level"/>
Note: The inputs are configured on the Connector Pin Configuration page.				
Phones 2 Message Levels				
0dB = Rated Phones Output				
Message 1:	-42.5 dB	<input type="range"/>	0 dB	[-20 dB] <input type="button" value="Default Level"/>
Message 2:	-42.5 dB	<input type="range"/>	0 dB	[-20 dB] <input type="button" value="Default Level"/>
Message 3:	-42.5 dB	<input type="range"/>	0 dB	[-20 dB] <input type="button" value="Default Level"/>

Phones 1 and Phones 2 Message Levels

For each of the Phones Outputs, the levels for the Messages can be adjusted from -42.5 to 0 dB. (default **-20 dB**)



Saving new Audio Files.

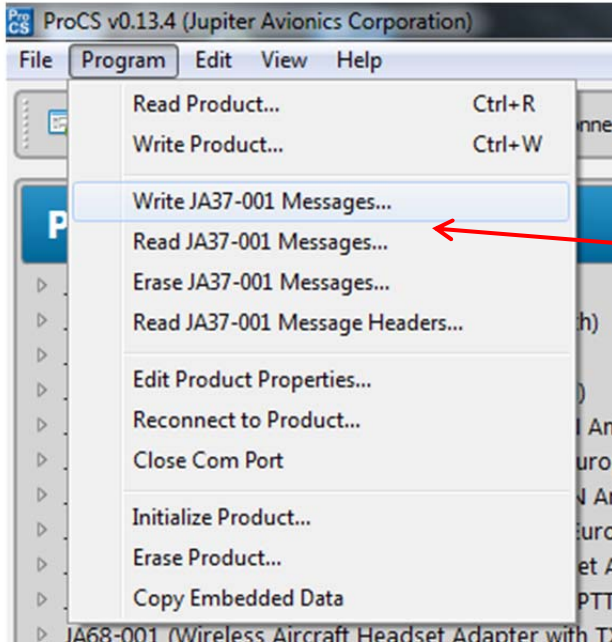

 **Note:** This pane will not have the full content shown here if no JA37-001 is connected.

When suitable alert messages are listed in the 'Audio Files' section, they are uploaded to the JA37-001 by selecting 'Program' from the main ProCS menu, and clicking on 'Write JA37-001 Messages...'

The window 'Select Messages to Write' (see below) will open, allowing the selected audio file message to be uploaded to the JA37-001. ProCS will automatically convert any WAV file to the required audio sample rate for the JA37-001.

A selection of suitable WAV files can be found on the JAC website:

Products>Software>Wave File Messages
www.jupiteravionics.com/productsoftware

The 'Select Messages to Write' window is shown. Similar windows will open for the 'Read' and 'Erase' selections. The desired message is chosen using the check box to the right of the message number, or by clicking on the 'Select All' button.

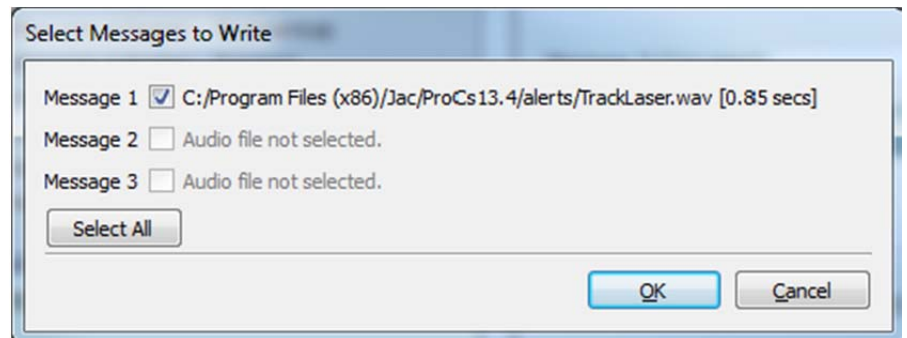

2.6.2.3 JA37-001 RX Audio Levels

When RX1 and RX2 Input are selected in the Configurable Pins section, the Phones 1 and Phones 2 RX AUDIO Input Levels may be selected from 0.25 to 8.50 Vrms (default **0.25 Vrms**), and the Gain can be selected from -20 to 19 dB (default **0 dB**).

The Output Level is adjusted indirectly by adjusting first the Input Level and then the Gain to select a suitable level from 0.25 to 8.50 Vrms (default **0.25 Vrms**).



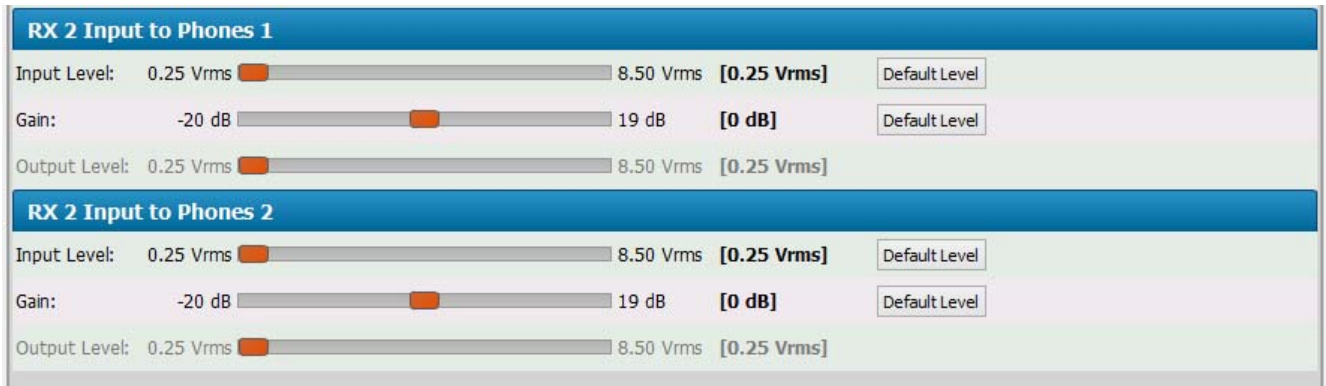

2.6.2.4 JA37-001 Connector Maps

The connector Maps and Interconnects for the unit showing any changes made to the connector pin selection (section 2.6.2.1 - [J1 Contacts Selection](#)) are shown in this section.

2.6.3 Other Configuration Features

In the JA37-001 Product Information Window, the model number, serial number and check sum of the JA37-001 Aural Message Generator - 3 Channel can be viewed.

2.7 Installation Kit

The kit required to install this unit is not included with the unit.

The installation kit (Part # INST-JA37) consists of the following:

Quantity	Description	JAC Part #
1	TAG ring 3/8" ID	CON-5500-0375
1	D-Sub 25-pin connector, hood and 25 crimp pins	CON-3420-0025
1	3/4" Inside Diameter, Heat Shrink Tube	WIR-HTSK-0750

2.7.1 Recommended Crimp tools

Connector Type	Hand crimp tool	Positioner	Insertion/extraction tool
Positronic	9507	9502-3	M81969/1-04
Positronic	AFM8 (Daniels)	M22520/2.08 KB-1	

2.8 Installation Drawings

The drawings and documents required for Installation can be found in [Appendix A](#) of this manual.

2.8.1 Generation of Custom Drawings

The connector map and interconnects in Appendix A of this manual are generic drawings based on the standard version of the JA37-001. However, if a unit has been configured using JAC's ProCS™ software to change connector pins, the software can be used to generate fully customized drawings for use by the installer.



JA37-001 Aural Message Generator - 3 Channel

SECTION 3 – OPERATION

3.1 Introduction

This section contains the operating instructions for the JA37-001.



Note: The JA37-001 has no integrated operator controls. However, a remote-mounted mute switch or button may be installed, which affects the operation of the unit.

3.2 Mute Switch/Button

If the JA37-001 is playing Alert messages (either because an alert input is active or when Power On Self-Test is occurring), momentary activation of the remote Message Mute switch or button stops all messages from playing until the next message is triggered.



Installation and Operation Manual

Appendix A - Installation Drawings

A1 Introduction

The drawings necessary for installation and troubleshooting of the JA37-001 Aural Message Generator - 3 Channel are in this Appendix, as listed below.



Note: Fully customized Connector Maps and Interconnects can be created using the ProCS software. Refer to the [ProCS™ manual](#) for further information.

A2 Installation Drawings

DOCUMENT	Rev
JA37-001 Connector Map	C
JA37-001 Interconnect	D
JA37-001 Mechanical Installation	D

P1
25 PIN FEMALE DMIN
MATING CONNECTOR

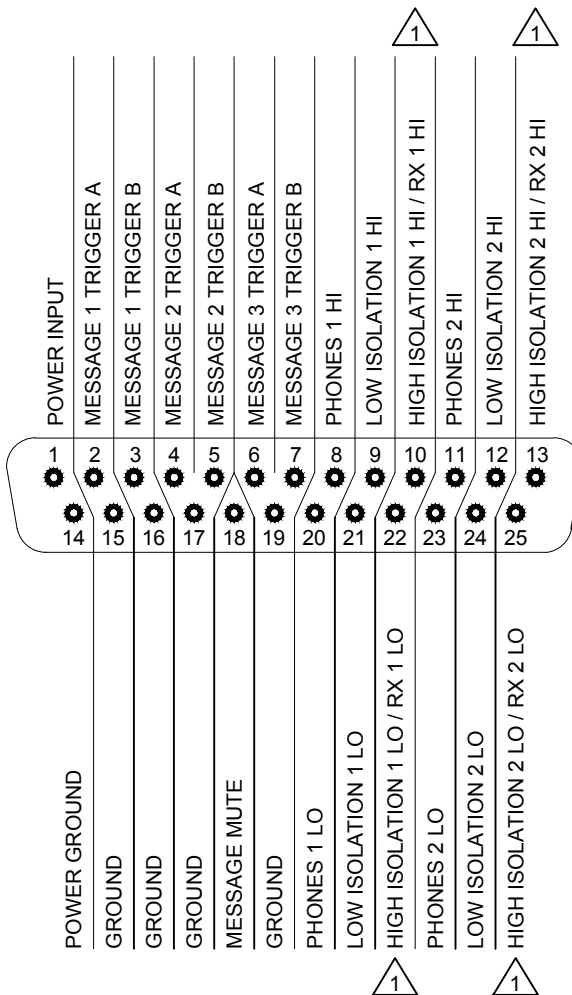

VIEW IS FROM REAR OF MATING CONNECTOR

Configurable Contact

PREPARED	TAT	JUPITER AVIONICS CORPORATION		
CHECKED				
APPROVED		Aural Message Generator P1 Connector Map		SHEET 1/2
CONFIDENTIAL & PROPRIETARY TO JUPITER AVIONICS CORP.		NCAGE CODE L00N3	PART NO. JA37-001	
		DOC NO. JA37-001 Connector Map Rev C.dwg		

CONFIGURATION CONNECTOR

P2

ACCEPTS THE FOLLOWING PLUG FORMATS

CAB-USB-0006 or
JA99-001 CONFIGURATION CABLE
4 POLE MALE 3.5MM PLUG

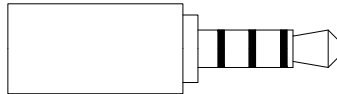

MATING PLUG NAMES

TIP: TX DATA
1ST RING: RX DATA
2ND RING: GROUND
3RD RING: MODE SELECT

JA37 SIGNAL NAMES



CONFIG DATA TO JA37
CONFIG DATA FROM JA37
GROUND
MODE SELECT

PREPARED	TAT	JUPITER AVIONICS CORPORATION		
CHECKED				
APPROVED		Aural Message Generator P2 Connector Map		
CONFIDENTIAL & PROPRIETARY TO JUPITER AVIONICS CORP.		NCAGE CODE	PART NO.	SHEET
		L00N3	JA37-001	2/2
		DOC NO.		
		JA37-001 Connector Map Rev C.dwg		

JA37-001 INTERCONNECT WIRING NOTES

NOTES



1. ALL WIRE SIZE SHOULD BE 24 AWG MIN UNLESS OTHERWISE SPECIFIED. UNSHIELDED WIRE SHOULD BE SELECTED PER FAA AC43.13-1B CHANGE 1 PARA 11-76 TO 11-78. WIRE TYPES SHOULD BE IN ACCORDANCE WITH MIL-W-22759 AS DESCRIBED IN FAA AC43.13-1B CHANGE 1 PARA 11-85 AND 11-86 AND LISTED IN TABLE 11-11 OR 11-12. ALL SHIELDED CABLE SHOULD BE IN ACCORDANCE WITH MIL-DTL-27500 (REVISION H OR LATER).
2. USE FOR SECOND SOURCE INPUT.
3. USE AS GROUND REFERENCE FOR SWITCH CLOSURE WHEN TRIGGERS CONFIGURED AS ACTIVE LOW.
4. PROVIDES 50% REDUCTION IN AUDIO POWER AND LESS LOADING.
5. PROVIDES 67% REDUCTION IN AUDIO POWER AND THE LEAST LOADING.
6. EXAMPLES OF MESSAGE TRIGGERS.
7. CONNECTION TO AIRFRAME GROUND SHOULD BE MADE WITH 20 AWG WIRE. LENGTH NOT TO EXCEED 3 FT (0.91 M).
8. CONNECTOR PIN HAS MORE THAN ONE FUNCTION. SEE THE OPTIONS SECTION OF THIS DRAWING FOR ALTERNATIVE INTERCONNECT WIRING.
9. CABLE SHIELDS AT THE JA37 CONNECTOR END SHOULD BE TERMINATED TO AIRFRAME GROUND USING THE TAG RING SUPPLIED IN THE INSTALLATION KIT OR EQUIVALENT.
10. A MOMENTARY DISCRETE INPUT TO MUTE PLAYING MESSAGE(S). MUTE OPERATES ON A FALLING EDGE. DOES NOT MUTE MESSAGES FROM SUBSEQUENT TRIGGERS.
11. EXAMPLE WHEN CONTACTS ARE CONFIGURED AS RX HI/LO.
12. EXAMPLE WHEN CONTACTS ARE CONFIGURED AS HIGH ISOLATION HI/LO.
13. METAL CHASSIS OF THE JA37 MUST BE ELECTRICALLY BONDED TO THE AIRCRAFT GROUND.

PREPARED	TAT			
CHECKED				
APPROVED		NCAGE CODE L00N3	PART NO. JA37-001	SHEET 1/4
CONFIDENTIAL & PROPRIETARY TO JUPITER AVIONICS CORP.		DOC NO. JA37-001 Interconnect Rev D.dwg		

JA37-001

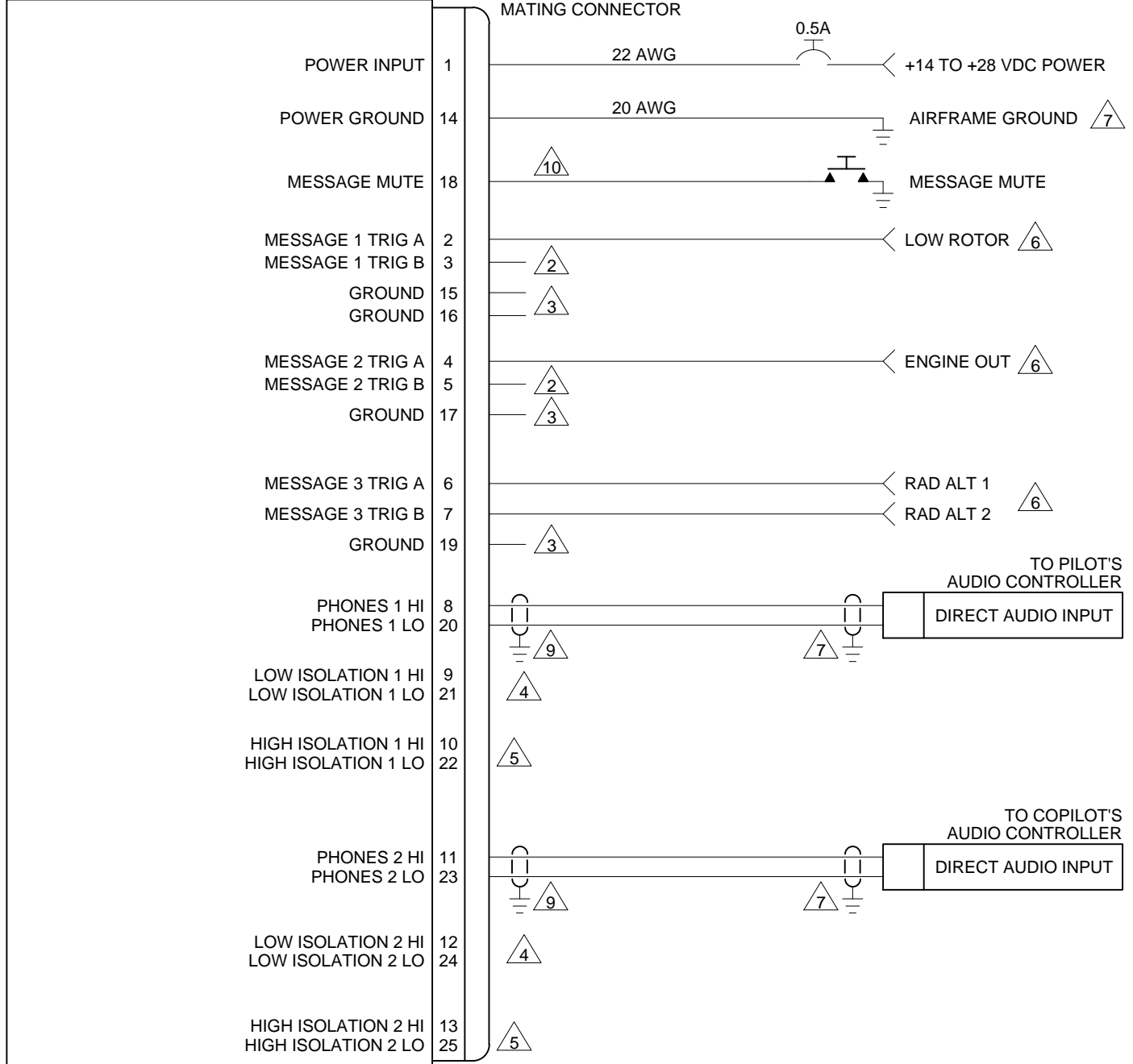
P1
25 PIN FEMALE DMIN
MATING CONNECTOR





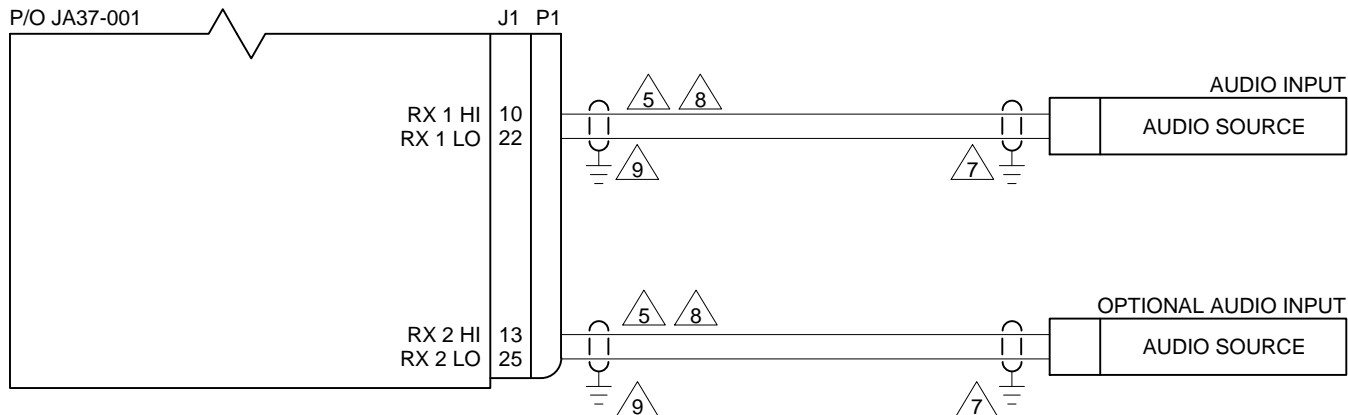

PREPARED	TAT			
CHECKED				
APPROVED		Aural Message Generator J1 Interconnect		SHEET
CONFIDENTIAL & PROPRIETARY TO JUPITER AVIONICS CORP.		NCAGE CODE L00N3	PART NO. JA37-001	2/4
		DOC NO. JA37-001 Interconnect Rev D.dwg		

OPTIONAL AUDIO INPUT 

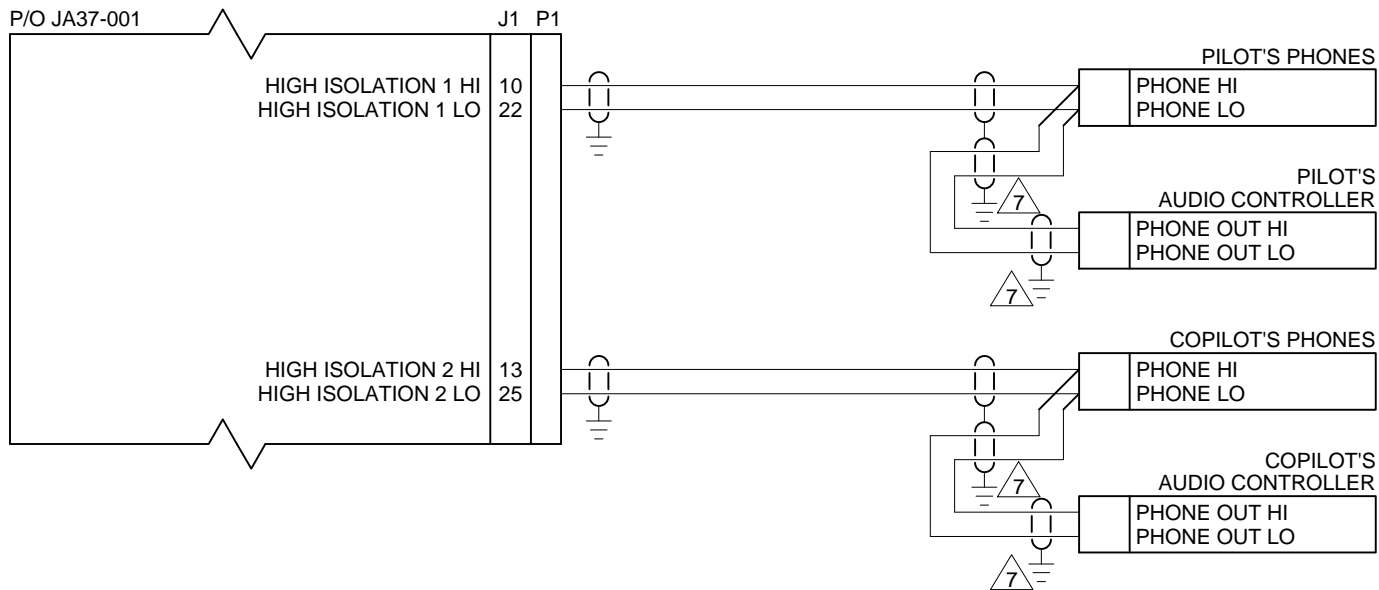





OPTIONAL CONNECTION TO PHONES 

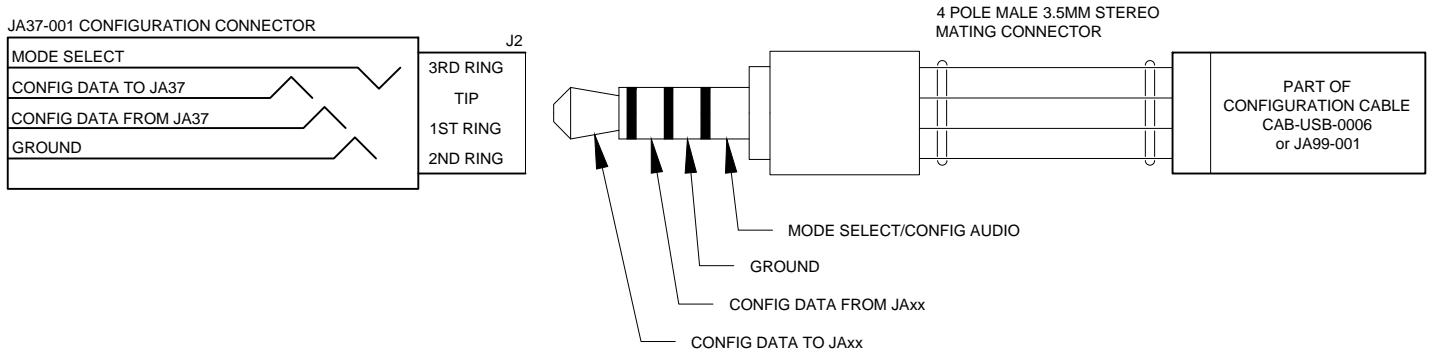

PREPARED	TAT			
CHECKED				
APPROVED		Aural Message Generator J1 Interconnect		SHEET
CONFIDENTIAL & PROPRIETARY TO JUPITER AVIONICS CORP.		NCAGE CODE L00N3	PART NO. JA37-001	3/4
		DOC NO. JA37-001 Interconnect Rev D.dwg		

CONFIGURATION CONNECTOR



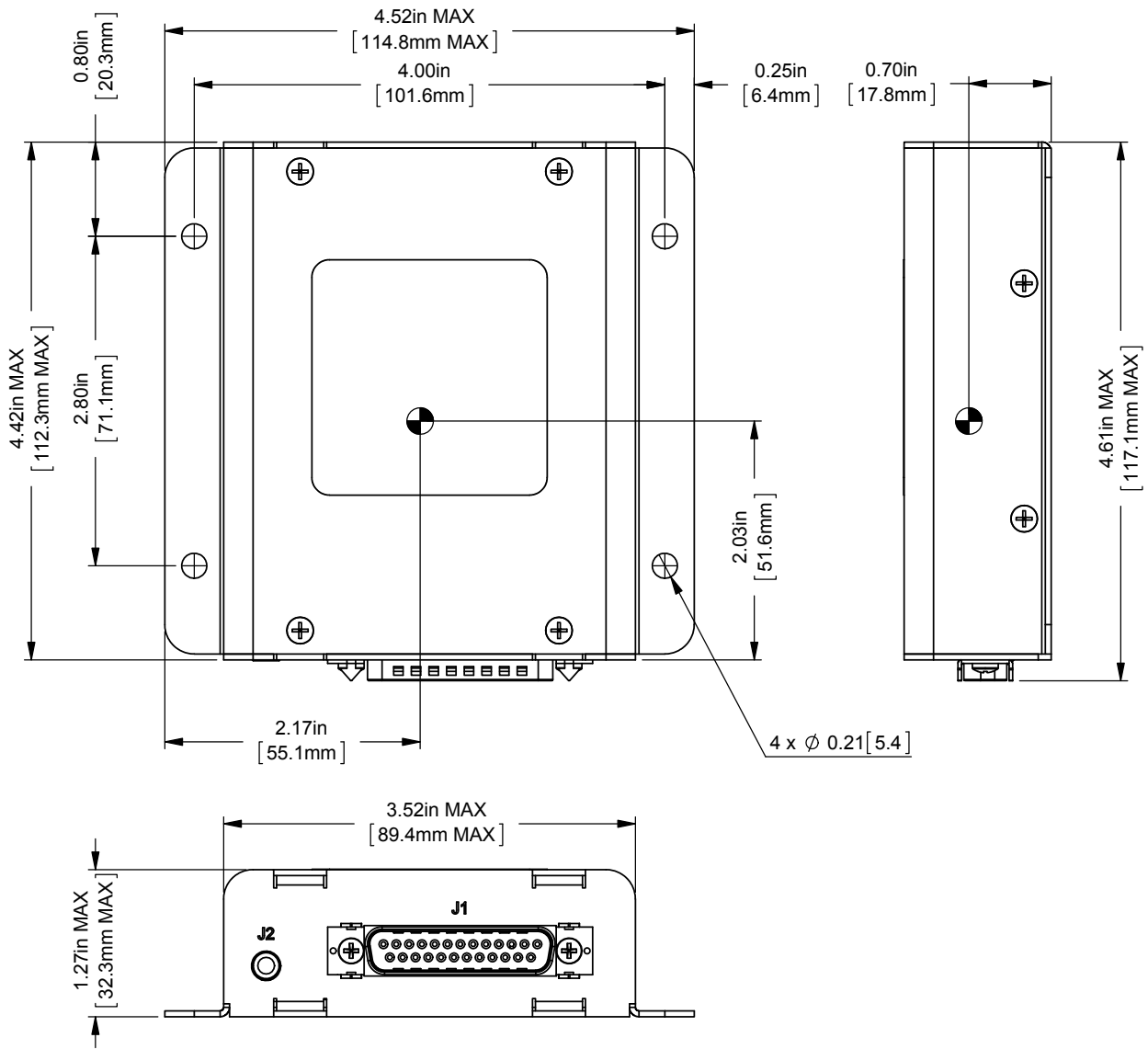

PREPARED	TAT	 JUPITER AVIONICS CORPORATION		
CHECKED				
APPROVED		Aural Message Generator J2 Interconnect		SHEET
CONFIDENTIAL & PROPRIETARY TO JUPITER AVIONICS CORP.		NCAGE CODE L00N3	PART NO. JA37-001	4/4
		DOC NO. JA37-001 Interconnect Rev D.dwg		



● CENTER OF GRAVITY
 ±0.03in [0.8mm]

WEIGHT: 0.54 lbs [0.24 kg] MAX.

UNLESS OTHERWISE SPECIFIED DIMENSIONS ARE IN INCHES ANGLES ARE IN DEGREES TOLERANCES: 1 DEC PLACE: ± 0.1 2 DEC PLACE: ± 0.01 3 DEC PLACE: ± 0.005 ANGLES: ± 0.5 DEG 	PREPARED	TAT	 JUPITER AVIONICS CORPORATION		TITLE	SHEET
	CHECKED					
	APPROVED		NCAGE CODE	PART NO.	1/1	
	MATERIAL: N/A	CONFIDENTIAL & PROPRIETARY TO JUPITER AVIONICS CORP.	L00N3	JA37-001		
FINISH: N/A	DRAWING NOT TO SCALE	DOC. NO.		JA37-001 Mechanical Installation Rev D.SLDDRW		



Installation Manual

Appendix B - Certification Documents



B1 Airworthiness Approval

Airworthiness approval of the JA37-001 may require completion of a TCCA Major Modification Report per CAR STD (AWM) 571 Appendix L or a FAA Form 337. The sample wording for a description of the work is provided to assist the Installing Agency in preparing Instructions for Continued Airworthiness (ICA) when replacing an existing Message Generator with a Jupiter Avionics JA37-001 Aural Message Generator - 3 Channel. This sample may be modified appropriately for new installations. It is the installer's responsibility to determine the applicability of the method used. Installations performed outside the USA and Canada must follow the applicable aviation authority's regulations.

Sample Wording:

Removed the existing [model] Message Generator and replaced with a Jupiter Avionics JA37-001 Aural Message Generator - 3 Channel in [aircraft location].

The JA37-001 is approved to CAN-TSO-C139 or FAA TSO-C139. The JA37-001 meets RTCA DO-160G environmental qualifications for this installation. See Section 1 of the JA37-001 Installation Manual.

Installed in accordance with the JA37-001 Installation Manual, Revision [], and AC 43.13-2, Chapters 2, and 3.

The JA37-001 Installation Manual provides detailed installation instructions and wiring diagrams (Section 2, and Appendices A and B).

Power is supplied to the JA37-001 through a 0.5 Amp circuit breaker.

Aircraft equipment list, weights and balance amended. Compass compensation checked and found to conform to applicable regulations.

B2 Instructions for Continued Airworthiness

Maintenance of the JA37-001 Aural Message Generator - 3 Channel is "on condition" only. Refer to the JA37-001 Maintenance Manual. Periodic maintenance of the JA37-001 is not required.

The following sample Instructions for Continued Airworthiness (ICA) provides assistance in preparing ICA for the Jupiter Avionics JA37-001 unit installation as part of a Type Certificate (TC) or Supplemental Type Certificate (STC) project to comply with CAR STD (AWM) 523/527/525/529.1529 or FAR 23/25/27/29.1529 "Instructions for Continued Airworthiness".

Items that may vary by aircraft make and model are shown in brackets ("[]") and should be filled in as appropriate. Some of the checklist items do not apply, in which case they should be marked "N/A" (Not Applicable).

Instructions for Continued Airworthiness, Jupiter Avionics JA37-001 Aural Message Generator - 3 Channel in an [Aircraft Make and Model]

1. Introduction

[Aircraft that has been altered: Registration number, Make, Model and Serial Number]

Content, Scope, Purpose and Arrangement: This document identifies the Instructions for Continued Airworthiness for a Jupiter Avionics JA37-001 installed in an [aircraft make and model].

Applicability: Applies to a Jupiter Avionics JA37-001 installed in an [aircraft make and model].

Definitions/Abbreviations: None, N/A.

Precautions: None, N/A.

Units of Measurement: None, N/A.

Referenced Publications: JA37-001 Installation Manual
JA37-001 Maintenance Manual
STC/TC # [applicable STC/TC number for the specific aircraft installation]

Distribution: This document should be a permanent aircraft record.



2. Description of the System/Alteration

Jupiter Avionics JA37-001 Aural Message Generator - 3 Channel with interface to external controls and [include other equipment/systems as appropriate]. Refer to Appendix A of this manual for interconnect information. Refer to aircraft manufacturer approved interconnect for actual installation.

3. Control, Operation Information

N/A

4. Servicing Information

N/A

5. Maintenance Instructions

Maintenance of the JA37-001 is 'on condition' only. Periodic maintenance is not required. Refer to the JA37-001 Maintenance Manual.

6. Troubleshooting Information

Refer to the JA37-001 Maintenance Manual.

7. Removal and Replacement Information

Refer to Section 2 of this manual - the JA37-001 Installation Manual. If the unit is removed and reinstalled, a functional check of the equipment should be conducted.

8. Diagrams

Refer to Appendix A of this manual - the JA37-001 Installation Manual - for installation drawings and interconnect examples.

9. Special Inspection Requirements

N/A

10. Application of Protective Treatments

N/A

11. Data: Relative to Structural Fasteners

JA37-001 and appropriate mounting hardware installation, removal and replacement should be in accordance with applicable provisions of AC 43.13-1B and AC 43.13-2A.

12. Special Tools

N/A

13. This Section is for Commuter Category Aircraft Only

A. **Electrical loads:** Refer to Section 1 of the JA37-001 Installation Manual.

B. **Methods of balancing flight controls:** N/A.

C. **Identification of primary and secondary structures:** N/A.

D. **Special repair methods applicable to the airplane:** N/A.

14. Overhaul Period

No additional overhaul time limitations.

15. Airworthiness Limitation Section

N/A

B3 Environmental Qualification Form

See next pages.



Prepared: SRM	Checked: 	Approved: 
----------------------	---------------------------------------------------------------------------------------------------	------------------------------------------------------------------------------------------------------

Nomenclature	Aural Message Generator - 3 Channel
Type/Model/ Part No.:	JA37-001
TSO No.:	CAN-TSO-C139; FAA TSO-C139
Manufacturer's Build Configuration:	JA37-001 Build Configuration Rev E
Manufacturer's Test Report:	JA37-001 Test Report (Qualification - Final) Rev A
Manufacturer's Specification and/or Other Applicable Specification:	JA37-001 Declaration of Design and Performance Rev B
Manufacturer:	Jupiter Avionics Corporation
Address:	1959 Kirschner Road, Kelowna, BC, Canada, V1Y 4N7
Revision & Change No of DO-160:	Rev. G dated December 8, 2010
Dates Tested:	2014 Feb 17 to 2014 Jul 02

CONDITIONS	SECTION	DESCRIPTION OF TESTS CONDUCTED
Temperature	4.5	Equipment tested to Category C4
Ground Survival Low Temperature	4.5.1	Equipment tested to Category C4 (-55 °C)
Short-Time Operating Low Temperature	4.5.1	Equipment tested to Category C4 (-45 °C)
Operating Low Temperature	4.5.2	Equipment tested to Category C4 (-45 °C)
Ground Survival High Temperature	4.5.3	Equipment tested to Category C4 (+85 °C)
Short-Time Operating High Temperature	4.5.3	Equipment tested to Category C4 (+70 °C)
Operating High Temperature	4.5.4	Equipment tested to Category C4 (+70 °C)
In-Flight Loss of Cooling	4.5.5	Equipment identified as Category X, no test performed
Altitude	4.6	Equipment tested to Category (A1)(D1)
Altitude	4.6.1	Equipment tested to Category D1 (50,000 ft)
Decompression	4.6.2	Equipment tested to Category A1 (8,000 to 50,000 ft)
Overpressure	4.6.3	Equipment tested to Category A1 (-15,000 ft)
Temperature Variation	5.0	Equipment tested to Category B (5 °C/min)
Humidity	6.0	Equipment tested to Category A (48 hours)
Operational Shock and Crash Safety	7.0	
Operational Shock	7.2.1	Equipment identified as Category B (6 g for 11 ms)
Crash Safety (impulse)	7.3.1	Equipment tested to Category B (20 g for 11 ms)
Crash Safety (sustained)	7.3.3	Equipment tested to Category B (20 g for 3 sec)
Vibration ¹	8.0	Equipment tested to Categories:
Fixed Wing - Sine	8.5.1	SM
Fixed Wing - Random	8.5.2	SB
Helicopter - Random, unknown	8.8.3	U2FF1



CONDITIONS	SECTION	DESCRIPTION OF TESTS CONDUCTED
Explosive Atmosphere	9.0	Equipment identified as Category X, no test performed
Waterproofness	10.0	Equipment identified as Category X, no test performed
Fluids Susceptibility	11.0	Equipment identified as Category X, no test performed
Sand and Dust	12.0	Equipment identified as Category X, no test performed
Fungus	13.0	Equipment identified as Category X, no test performed
Salt Fog Test	14.0	Equipment identified as Category X, no test performed
Magnetic Effect	15.0	Equipment tested to Category Z (≤ 0.3 m)
Power Input DC Equipment DC Current Ripple DC Inrush	16.0	Equipment tested to Category: (ZXX)(BXX) Z (+28 Vdc equipment), B (+14 Vdc and + 28 Vdc equipment) X, no test performed X, no test performed
Voltage Spike	17.0	Equipment tested to Category A (600Vp, 10 us)
Audio Frequency Susceptibility	18.0	Equipment tested to Category Z (+28 Vdc equipment) Equipment tested to Category B (+14 Vdc equipment)
Induced Signal Susceptibility Magnetic Fields into Equipment Magnetic Fields into Interconnect Electric Fields into Interconnect Voltage Spikes into Interconnect	19.0 19.3.1 19.3.3 19.3.4 19.3.5	Equipment tested to Category ZCX 20 A at 400Hz 30 A·m at 400Hz 1800 V·m at 400Hz 3.0 m
Radio Frequency Susceptibility ² Radiated Conducted	20.0	Equipment tested to Category RR R (20 V/m CW&SW) and (150 V/m PM) R (30 mA)
Radio Frequency Emission ²	21.0	Equipment tested to Category H
Lightning Induced Transient Susceptibility ² Pin Injection Cable Bundle Single and Multiple Stroke Cable Bundle Multiple Burst	22.0	Equipment tested to Category A3XXL3 Equipment tested to Waveform Set A, Test Level 3 Equipment identified as Category XX, no test performed Equipment tested to Waveform Set L, Test Level 3
Lightning Direct Effects	23.0	Equipment identified as Category X, no test performed
Icing	24.0	Equipment identified as Category X, no test performed
Electrostatic Discharge	25.0	Equipment identified as Category X, no test performed
Fire, Flammability	26.0	Equipment identified as Category C.
Other Tests	N/A	N/A

REMARKS

¹ During exposure to vibration test conditions all critical resonances changed frequency less than 1%.

² Testing performed at CKC Laboratories in Bothell, WA, USA.
See report JA37-001 Test Report (CKC Labs DO-160G Section 20 21 22 - 20140519 to 23) Rev A