



JUPITER AVIONICS
CORPORATION

JA39-075

**Low Impedance Headset Adapter
75 Ohm Mic - 150 Ohm Phones**



Installation Manual

Rev. A

**Jupiter Avionics Corporation
1959 Kirschner Road
Kelowna BC
Canada V1Y 4N7
Tel: +1 778 478 2232
Toll-Free: 1 855 478 2232
www.jupiteravionics.com**



Copyright 2015 Jupiter Avionics Corp.

All rights reserved

Jupiter Avionics Corporation (JAC) permits a single copy of this manual to be printed or downloaded for the express use of an installing agency. Any such electronic or printed copy of this manual must contain the complete text of this copyright notice. Any unauthorized commercial distribution of this manual is strictly prohibited. Except as described above, no part of this manual may be reproduced, copied, transmitted, disseminated, downloaded, or stored in any storage medium for any purpose without the express prior written consent of JAC.

IMPORTANT:

Information in this document is subject to change without notice.
 To confirm the current revision status of this manual, visit the JAC website:
www.jupiteravionics.com

RECORD OF REVISIONS			
Revision	Rev Date	Description	ECR
A	Jun 2015	Initial release, Serial number 1001 and higher.	3271

Prepared: <p style="text-align: center;">MPB</p>	Checked: <div style="text-align: center;"> </div>	Approved: <div style="text-align: center;"> </div>
---	--	---



Table of Contents

SECTION 1 - DESCRIPTION	1
1.1 System Overview	1
1.2 Features Overview	1
1.3 Inputs and Outputs	1
1.3.1 Inputs	1
1.3.2 Outputs	1
1.3.3 Mic Bias Voltage Supply	1
1.4 Specifications	2
1.4.1 Electrical Specifications	2
1.4.2 Mechanical Specifications	2
SECTION 2 – INSTALLATION	3
2.1 Introduction	3
2.2 Continued Airworthiness	3
2.3 Unpacking and Inspecting Equipment	3
2.3.1 Warranty	3
2.4 Installation Procedures	3
2.4.1 Installation Limitations	3
2.4.2 Cabling and Wiring	3
2.4.3 Mechanical Installation	3
2.4.4 In-Line PTT Cordsets	4
2.4.5 Post Installation Checks	4
2.5 System Operation	4
2.5.1 Microphone Operation	4
2.5.2 Phones Operation	4
2.6 Installation Kit	4
2.7 Installation Drawings	4
Appendix A - Installation Drawings	A1
A1 Introduction	A1
A2 Installation Drawings	A1

JA39-075 Low Impedance Headset Adapter - 75Ω Mic - 150Ω Phones

SECTION 1 - DESCRIPTION

1.1 System Overview

The JA39-075 Low Impedance Headset Adapter - 75 Ohm Mic - 150 Ohm Phones allows a low impedance headset to be used with a civilian aviation audio controller. The JA39-075 operates using the microphone bias supply of the audio controller and requires no other external power. The phones audio from the audio controller is routed directly through to the Headphone.

The JA39-075 is a simple plug and play solution that uses the microphone bias provided by the audio system to amplify the Low Impedance Mic Signal to an appropriate level, and matches the headset impedance via transformer.

1.2 Features Overview

The JA39-075 features one male and one female TJ-120 telephone jack and follows industry standard interconnect for aviation headsets.

The JA39-075 unit features an industry standard headset pin-out to allow plug and play operation.

The JA39-075 plugs in-line with the headset cord.

The JA39-075 uses a metal enclosure to shield the circuitry from Radio Frequency Interference.

1.3 Inputs and Outputs

Refer to the JA39-075 connector maps for the mating connector designators and pin assignments for the input and output signals.

1.3.1 Inputs

Name	Qty	Type
MIC INPUT HI/LO	2	Audio signal
PHONES INPUT HI/LO	2	Audio signal

1.3.2 Outputs

Name	Qty	Type
MIC OUPUT HI/LO	2	Audio signal
PHONES OUPUT HI/LO	2	Audio signal

1.3.3 Mic Bias Voltage Supply

The Microphone Output accepts a DC MIC INPUT bias voltage supply from the Audio Controller.



1.4 Specifications

1.4.1 Electrical Specifications

Power Input

Primary nominal voltage	12.0 Vdc (Mic Bias)
Maximum voltage	16.0 Vdc
Minimum voltage	10.0 Vdc
Input current at 12 Vdc	≤ 0.01 A

1.4.1.1 Audio Performance

Rated Input Level

Phones rated input level	7.75 Vrms ±10%
Microphone input level	850 uVrms ±10%

Rated Output Level

Phone rated output into 150 Ω	7.75 Vrms ±10%
Microphone rated output into 150 Ω	250 mVrms±10%

Audio Frequency Response

Audio output audio frequency response	≤3dB from 300 to 6000 Hz
---------------------------------------	--------------------------

Distortion Characteristics

Audio output distortion at rated power	≤10%
--	------

Input Impedance

Microphone input Impedance	75 Ω ±10%
Phones input Impedance	150 Ω ±10%

Audio Noise Level without Signal

Noise level below the rated output	≥55 dB
------------------------------------	--------

1.4.1.2 Audio Performance, Other

Microphone input designed for MIC type	dynamic
Phones output circuitry type	transformer coupled

1.4.2 Mechanical Specifications

Height	3.14 in [79.8 mm] max
Depth	1.05 in [26.7 mm] max
Width	0.73 in [18.5 mm] max
Weight	0.11 lbs. [51.2 g] max
Connectors (2):	J1 One 4 pole TP-120 plug J2 One 4 pole TJT-120 jack
Mounting	Insertion into TJ-120 jack
Installation Kit	Not Required.



JA39-075 Low Impedance Headset Adapter - 75Ω Mic - 150Ω Phones

SECTION 2 – INSTALLATION

2.1 Introduction

This section contains unpacking and inspection procedures, installation information, and post-installation checks.

2.2 Continued Airworthiness

Maintenance of the JA39-075 is on condition only. Scheduled inspection and/or periodic maintenance of this unit is not required.

2.3 Unpacking and Inspecting Equipment

Unpack the equipment carefully. Check for shipping damage and report any problems to the relevant carrier. Confirm that the Certificate of Conformance is included. Complete the on-line warranty card from the Jupiter Avionics Corporation (JAC) website – www.jupiteravionics.com/warranty.

2.3.1 Warranty

All JA39 products manufactured by JAC are warranted to be free of defects in workmanship or performance for 1 year from the date of purchase from an approved JAC dealer or agency. This warranty covers the cost of all materials and labour to repair or replace the unit, but does not include the cost of transporting the defective unit to and from JAC or its designated warranty repair centre, or of removing and replacing the defective unit in the aircraft. This warranty does not cover failures due to abuse, misuse, accident, or unauthorized alteration or repairs.

If the on-line warranty card is not completed, the product will be warranted from the date of manufacture.

Contact JAC for return authorization, and for any questions regarding this warranty and how it applies to your unit(s). JAC is the final arbiter concerning warranty issues.

2.4 Installation Procedures



WARNING: Loud noise can cause hearing damage. Set audio system headset volumes to minimum before conducting tests, and slowly increase the volume to a comfortable listening level.

2.4.1 Installation Limitations

The JA39 may be installed only by following the applicable airworthiness requirements.

2.4.2 Cabling and Wiring

The JA39 plugs directly into a standard aircraft audio system headset connector. All wires to said connector shall be selected in accordance with the original aircraft manufacturer's maintenance instructions, or AC43.13-1B Change 1, Paragraphs 11-76 through 11-78. Unshielded wire types shall qualify to MIL-W-22759 as specified in AC43.13-1B Change 1, Paragraphs 11-85, 11-86, and listed in Table 11-11. For shielded wire applications, use Tefzel MIL-C-27500 shielded wire with tag ring or equivalent (for shield terminations) to make the most compact and easily terminated interconnect. Follow the Connector Map in Appendix A of this manual.

2.4.3 Mechanical Installation

The JA39-075 can be mounted in any attitude and location sufficient clearance for the connector body and headset plug. It requires no direct cooling.

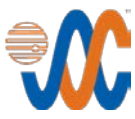

CAUTION: When plugged in to a headset audio connector, the JA39 could create excessive strain on the connector. Ensure that the JA39 is protected from impact, and that no tension is applied to any attached headset cord.

2.4.4 In-Line PTT Cordsets

If in-line PTT cordsets (drop cords) are used, be aware that incorrectly configured or improperly shielded in-line PTT cordsets can lead to significant audio problems.

2.4.5 Post Installation Checks

2.4.5.1 Configuration

The JA39 has no configuration options.

2.4.5.2 Power on Checks.

Power up the aircraft's systems and confirm operation of all functions of the JA39.

- a) Begin with a low impedance headset attached. Confirm correct operation for both Mic and phones output. Do not proceed until the headsets are functioning correctly.
- b) Unusual buzzes, hums or other background audio are symptomatic of multiple grounds, or noisy external systems such as blowers or pumps sharing wiring with the audio system.

2.5 System Operation

The JA39-075 is designed to operate regardless of the input and output polarities of the attached audio controller and headset.

2.5.1 Microphone Operation

The JA39-075 amplifies the MIC INPUT audio and routes it to the MIC OUTPUT.

2.5.2 Phones Operation

The JA39-075 impedance matches the PHONES INPUT audio and routes it to the PHONES OUTPUT.

2.6 Installation Kit

The JA39-075 does not require an installation kit.

2.7 Installation Drawings

The drawings and documents required for Installation can be found in [Appendix A](#) of this manual.

Installation Manual

Appendix A - Installation Drawings

A1 Introduction

The drawings necessary for installation and troubleshooting of the JA39-075 Low Impedance Headset Adapter are in this Appendix, as listed below.

A2 Installation Drawings

DOCUMENT	Rev
JA39-075 Connector Map	A
JA39-075 Interconnect	A
JA39-075 Mechanical Installation	A

Aircraft or wiJAC Connector

P1

TJ-120 or U-92 A/U
MATING CONNECTOR

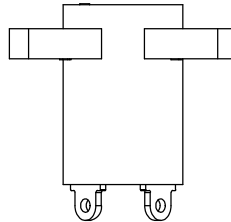

PIN 1: Microphone Input Hi
PIN 2: Phones Output Hi
PIN 3: Microphone Input Lo
PIN 4: Phones Output Lo

View of Aircraft mating connector

Headset Connector

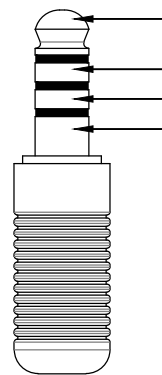

P2

U174/U or U-93A/U
MATING CONNECTOR



TIP / PIN 1: Microphone Input Hi
1st Ring / PIN 2: Phones Output Hi
2nd Ring / PIN 3: Microphone Input Lo
3rd Ring / PIN 4: Phones Output Lo

View of Headset mating connector

PREPARED	TAT			
CHECKED				
APPROVED		Low Impedance Headset Adapter 75 Ohm Mic - 150 Ohm Phones		
CONFIDENTIAL & PROPRIETARY TO JUPITER AVIONICS CORP.		NCAGE CODE L00N3	PART NO. JA39-075	SHEET 1/1
		DOC NO. JA39-075 Connector Map Rev A.dwg		

Aircraft Intercom System

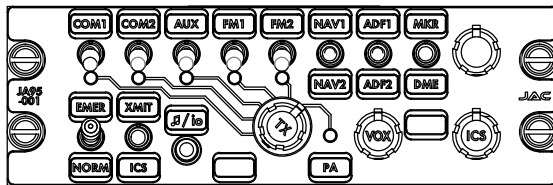

Aircraft Headset Jack

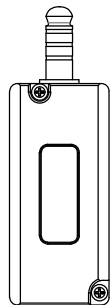



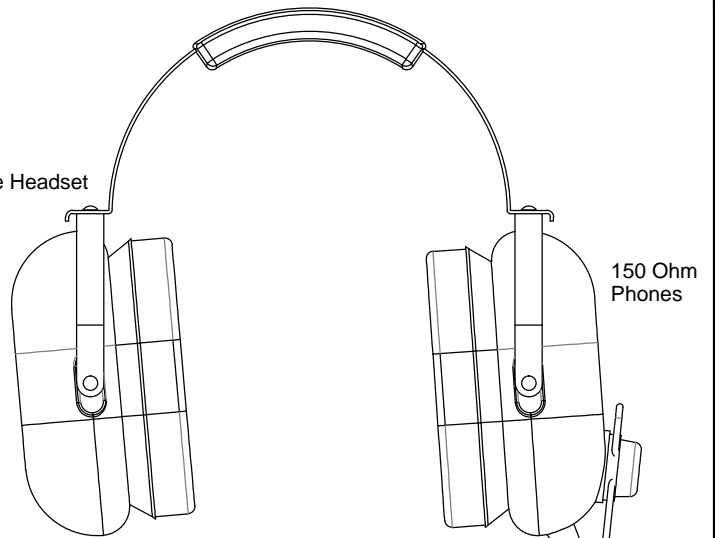

JA39-075
Low Impedance
Headset Adapter

Low Impedance Headset

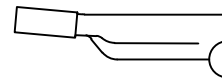

75 Ohm Mic

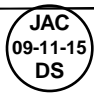

PREPARED	TAT			
CHECKED				
APPROVED		Low Impedance Headset Adapter 75 Ohm Mic - 150 Ohm Phones		SHEET
CONFIDENTIAL & PROPRIETARY TO JUPITER AVIONICS CORP.		NCAGE CODE	PART NO.	1/3
		L00N3	JA39-075	
		DOC NO. JA39-075 Interconnect Rev A.dwg		

Low Impedance Headset

150 Ohm
Phones

75 Ohm Mic

High Impedance
Aircraft Intercom System

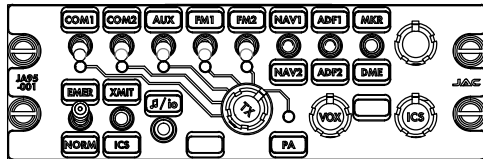

Aircraft Headset Jack

JA61-001
Wireless Aircraft
Intercom Adapter

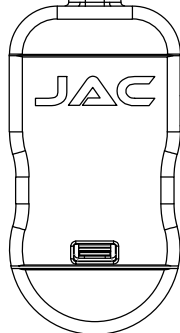

JA39-075
Low Impedance
Headset Adapter

JA60-001
Wireless Aircraft
Headset Adapter

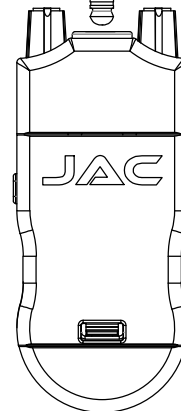

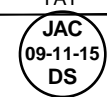
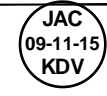
PREPARED	TAT			
CHECKED				
APPROVED		Low Impedance Headset Adapter 75 Ohm Mic - 150 Ohm Phones		SHEET
CONFIDENTIAL & PROPRIETARY TO JUPITER AVIONICS CORP.		NCAGE CODE	PART NO.	2/3
		L00N3	JA39-075	
		DOC NO. JA39-075 Interconnect Rev A.dwg		

Low Impedance Headset

150 Ohm Phones

Low Impedance Aircraft Intercom System

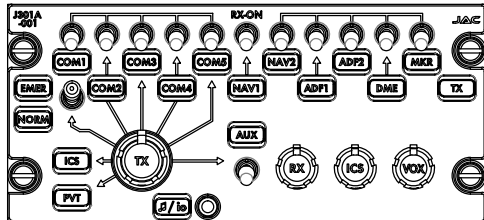

Aircraft Headset Jack

75 Ohm Mic

WJ39-075
JA61 Low Impedance Adapter

JA39-075
Low Impedance Headset Adapter

JA61-001
Wireless Aircraft Intercom Adapter

JA60-001
Wireless Aircraft Headset Adapter

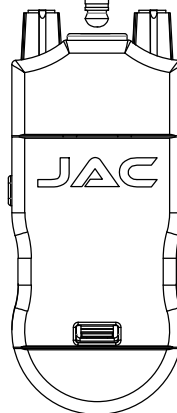
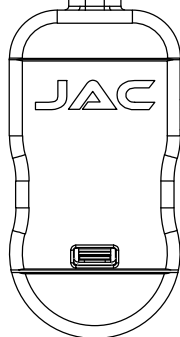

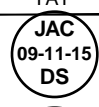
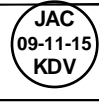
PREPARED	TAT			
CHECKED				
APPROVED		Low Impedance Headset Adapter 75 Ohm Mic - 150 Ohm Phones		SHEET
CONFIDENTIAL & PROPRIETARY TO JUPITER AVIONICS CORP.		NCAGE CODE	PART NO.	3/3
		L00N3	JA39-075	
		DOC NO. JA39-075 Interconnect Rev A.dwg		

3.14in MAX
[79.8mm MAX]

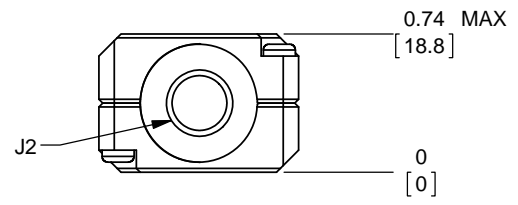
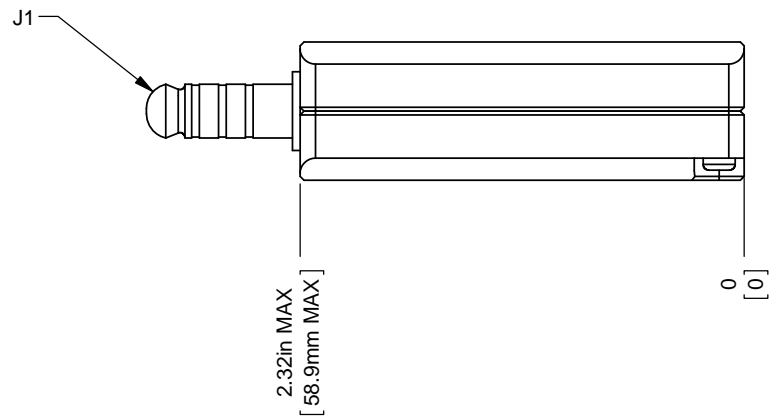
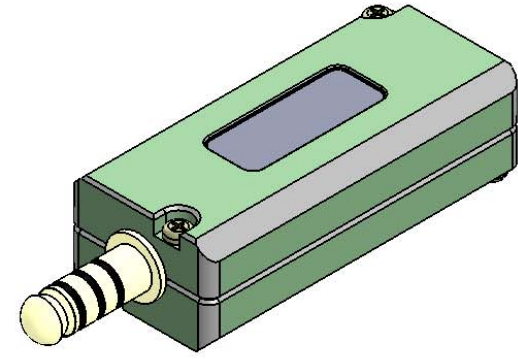
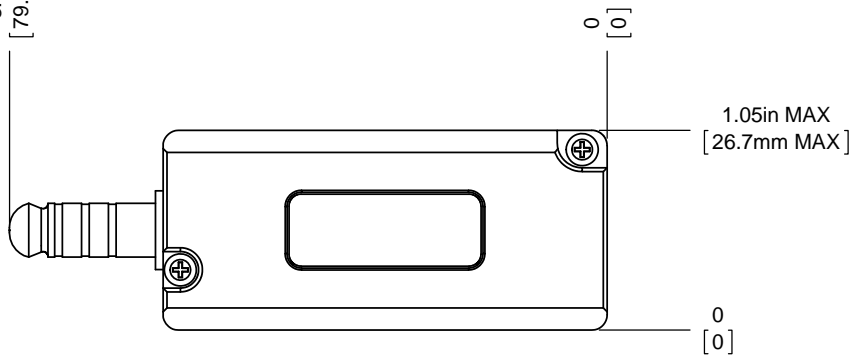

WEIGHT: 0.11 lbs [51.2 g] MAX.

UNLESS OTHERWISE SPECIFIED
DIMENSIONS ARE IN INCHES
ANGLES ARE IN DEGREES
TOLERANCES:
1 DEC PLACE: ± 0.1
2 DEC PLACE: ± 0.01
3 DEC PLACE: ± 0.005
ANGLES: ± 0.5 DEG

MATERIAL: N/A
FINISH: N/A

PREPARED	TAT
CHECKED	JAC 09-11-15 DS
APPROVED	JAC 09-11-15 KDV
CONFIDENTIAL & PROPRIETARY TO JUPITER AVIONICS CORP. DRAWING NOT TO SCALE	

JUPITER AVIONICS CORPORATION	
TITLE Low Impedance Headset Adapter - 75 Ohm Mic - 150 Ohm Phones	
NCAGE CODE L00N3	PART NO. JA39-075
DOC. NO. JA39-075 Mechanical Installation Rev A.SLDDRW	
SHEET 1/1	