

Manual Number
9017782
Revision Q
March 12, 2024



MD302 SERIES

Standby Attitude Module (SAM)

FOREWORD

This manual provides information intended for use by persons who, in accordance with current regulatory requirements, are qualified to install this equipment. If further information is required, please contact:

Mid-Continent Instruments and Avionics
Attn: Customer Service Dept.
9400 E. 34th Street N.
Wichita, KS 67226 USA
PH (316) 630-0101
FX (316) 630-0723
www.mcico.com

We welcome your comments concerning this manual. Although every effort has been made to keep it free of errors, some may occur. When reporting a specific problem, please describe it briefly and include the manual part number, the paragraph/figure/table reference and the page number. Send your comments to:

Mid-Continent Instruments and Avionics
Attn: Technical Publications
9400 E. 34th Street N.
Wichita, KS 67226 USA
PH (316) 630-0101
FX (316) 630-0723
ks.customerservice@mcico.com

All products produced by Mid-Continent Instrument Co., Inc., including those identified as Mid-Continent Instruments and Avionics or True Blue Power, are designed and manufactured in Wichita, KS, USA.

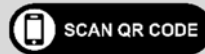

Download the current version of this installation manual using your smartphone or tablet.

© Copyright 2019
Mid-Continent Instrument Co., Inc.

TABLE OF CONTENTS

SECTION 1	GENERAL DESCRIPTION	4
1.1	INTRODUCTION	4
1.2	TECHNICAL SPECIFICATIONS	5
1.3	ARINC DATA LABELS	6
1.4	IMPORTANT SAFETY INFORMATION	7
SECTION 2	PRE-INSTALLATION CONSIDERATIONS	8
2.1	EQUIPMENT LOCATION	8
2.2	LIMITATIONS	10
2.3	MODIFICATION	11
SECTION 3	INSTALLATION	12
3.1	GENERAL INFORMATION	12
3.2	PARTS LIST	12
3.3	CABLE HARNESS	12
3.4	PITOT / STATIC CONNECTIONS	15
3.5	MOUNTING	17
3.6	INSTALLATION COMPLETION	17
SECTION 4	OPERATION	20
4.1	USER INTERFACE	20
4.2	PRE-FLIGHT MODE	20
4.3	FLIGHT MODE	22
4.4	EMERGENCY OPERATION	38
4.5	CONFIGURATION SETUP	40
SECTION 5	CONFORMANCE	62
5.1	INSTRUCTIONS FOR CONTINUED AIRWORTHINESS	62
5.2	ENVIRONMENTAL QUALIFICATION STATEMENT	69

REVISION HISTORY

Rev	Date	Detail	Approved
1	09/10/2012	Engineering release.	BAW
A	10/02/2012	Initial release.	BAW
B	10/31/2012	Updates implemented.	BAW
C	11/21/2012	Remove "Pending" from certification table 1.4. Update Section 2.4. Added panel orientation graphic to Figure 2.1. Updated lightning callout to H3B3L3. Various minor corrections. Add Figure 3.6. Consolidate Figures 3.10/3.11 and Figures 3.12/3.13.	BAW
D	05/06/2013	Updated logos to include registered trademarks. Updated screen captures to reflect software version 1.0.1. Update DO-160 qualification to include helicopter vibration. Various minor corrections.	BAW
E	10/11/2013	Incorporated changes associated with software version 1.0.3. Added label 204 to ARINC outputs. Added Baro Sync information to Section 3.3.1.2.	BAW
F	03/17/2014	Added Mod 1 Configuration	BMC
G	12/22/2014	Incorporated changes associated with software version 1.0.4. Added labels 014 and 320 to ARINC inputs. Added Heading Operation to Section 3.3.1.1.1. Added Configure Preview to Section 4.1.1. Added VNE Configuration to Section 4.4.5. Added Heading Display to Section 4.5. Added Calibrate Pressures to Section 4.6. Updated screen captures where applicable.	BMC
H	01/07/2015	Updated Section 5.1 to include revised software update procedure.	BMC
J	08/27/2015	Incorporated changes associated with software version 1.0.5.	BMC
K	05/11/2018	Added TSO C6e and support information for use of MD32 Magnetometer. ARINC pass-through feature. Updated pinout. Add patent reference.	BAW
L	09/14/2018	Added -7 and -8 configurations and Type 2 battery information. Added SSEC ARINC label.	MEK
M	04/25/2019	Revised limitations associated with -45°C operation. Corrected ARINC labels 234, 235.	CAS
N	07/02/2020	Updated style and brand to meet Marketing and Engineering guidelines. Moved Operation from Section 3 to Section 4. Updated images to reflect most current display. Added Section 4.5.8, Configure Auto-Off.	DLR
P	01/06/2022	Updated Section 3.2 and 3.4 with o-ring replacement info.	DLR
Q	03/12/2024	Updated Section 5.1.3 with required power on capacity	KEY

SECTION 1 GENERAL DESCRIPTION

1.1 INTRODUCTION

The model MD302 series SAM® Standby Attitude Module is a self-contained situational awareness instrument that provides aircraft attitude, altitude, airspeed, and slip indication, plus available heading data with the optionally installed MD32 Magnetometer. The compact and innovative design of the MD302 is specifically developed for maximum flexibility for installation in retrofit or modern instrument panels. Its size, extra-wide viewing angle and AnyWay™ selectable orientation allows it to be installed almost anywhere in the instrument panel and in less space than traditional, 2-inch mechanical standby or primary flight instruments.

Regardless of the aircraft you are flying, the MD302 is a great fit. With a 10 to 32 volt DC input range, the unit will work with 14 or 28V aircraft electrical buses and the selectable lighting input allows operation with 5, 14 or 28V lighting systems. The operation and certification of the MD302 make it well suited for Part 23 and 25 fixed-wing applications as well as Part 27 and 29 rotorcraft.

The MD302 provides critical flight and situational data to the pilot and crew under any circumstances you are likely to encounter. The design is built around a solid-state electronic sensor array for high reliability and contains an integral and rechargeable battery that can power the unit for up to two hours if main aircraft power is lost. The dual, high-resolution LCD display uses smooth graphics, daylight-readable brightness and a configurable lighting response curve to ensure optimal visibility in all conditions.

The user interface of the product allows for simple, intuitive operation using a single push-and-turn control knob that easily navigates through the user options and menu screens. The interactivity of the unit means that it can receive and transmit ARINC 429 data communications. Functional outputs of attitude, altitude, and airspeed can be used for monitoring or backup information while baro input data can be received and will synchronize the baro setting with the primary system to eliminate redundant task loading for the pilot.

The MD302 is an excellent complement to your avionics suite as a reliable and state-of-the-art instrument that is an essential part of any instrument panel.



1.2 TECHNICAL SPECIFICATIONS

Electrical Attributes	
Input Voltage:	10-32 VDC
Input Power: (nominal)	6 watts (0.22A @ 28VDC)
(maximum)	40 watts max (when charging and heating battery + display)
Output Power:	Reserved for MD32 Remote Magnetometer (pin 11)
Lighting Input:	5, 14, or 28VDC or automatic photocell control
Input Data:	ARINC 429 (see Table 1.1)
Output Data:	ARINC 429 (see Table 1.1); discrete valid signal to ground; invalid signal is open (pin 2)
Battery Backup:	
Type 1 (Lithium-ion)	3 cells in series x 3.3V x 1.0Ah = 9.9 Watt-hours
Type 2 (Nickel Metal Hydride)	5 cells in series x 1.2V x 2.0Ah = 12 Watt-hours

Physical Attributes	
Weight:	1.6 pounds (0.73 kg)
Dimensions: (without connectors, mates & knob)	Bezel: 2.37" x 5.50" x 0.33" (HxWxD) Chassis: 2.31" x 3.16" x 4.84" (HxWxD)
Mating Connectors:	15-pin D-Sub with Configuration Module Pneumatic fittings
Mounting:	Panel mount from front; uses (4) #6-32 cap screws and Nutplate (included)

Performance Limits		
Attitude:	Pitch Angle	No limits (360°+)
	Pitch Rate	300° per second max
	Roll Angle	No limits (360°+)
	Roll Rate	300° per second max
Altitude:	Range	-1,500 to +55,000 feet (available in meters)
	Barometer	28.00 to 31.00 inches of mercury (available in mbar)
Airspeed:	Range	20 to 500 knots (available in mph or kph)

Qualifications	
Certifications:	FAA TSO-C2d (Type B), C3e, C4c, C6e, C10b, C106, C113a, C179a EASA ETSO-C2d, C3d, C4c, C6e, C10b, C106, C113, C179a
Environmental Qualification:	RTCA DO-160G (details listed in Section 5.2)
Software Qualification:	RTCA DO-178B, Design Assurance Level A
Complex Hardware Qualification:	RTCA DO-254, Design Assurance Level A
Lithium-ion Qualification:	UL 1642; RTCA DO-311; RTCA DO-347 (partial)

Rights	
U.S. Patent No.:	9,739,611



1.3 ARINC DATA LABELS

All labels are defined as Equipment ID 038 in BNR format. High and Low speed options for ARINC outputs are configurable. See Section 4.5.3.

ARINC 429 Input		Speed	
Label	Description	High	Low
014	magnetic heading	X	X
203	altitude (rel 29.92)	X	X
204	baro altitude	X	X
234	baro correction (mbar)	X	X
235	baro correction (inHg)	X	X
320	magnetic heading	X	X

ARINC 429 Output		Speed	
Label	Description	High	Low
203	altitude (rel 29.92)	X	X
204	baro altitude	X	X
205	mach number	X	X
206	computed airspeed	X	X
212	altitude rate	X	X
215	impact pressure	X	X
217	static pressure	X	X
234	baro correction (mbar)	X	X
235	baro correction (inHg)	X	X
320	magnetic heading	X	
324	pitch attitude	X	X
325	roll angle	X	X
326	body pitch rate	X	
327	body roll rate	X	
330	body yaw rate	X	
331	body longitudinal acceleration	X	
332	body lateral acceleration	X	
333	body normal acceleration	X	
336	inertial pitch rate	X	
337	inertial roll rate	X	
340	inertial yaw rate	X	
350	software version	X	
351	reserved custom label	X	
353	SSEC identification	X	
364	vertical acceleration	X	
377	specific equipment id	X	X

TABLE 1.1

1.4 IMPORTANT SAFETY INFORMATION

Read this safety information **BEFORE** maintaining or servicing the unit.

1.4.1 Symbol Definition

This section describes the precautions necessary for safe operations. The following safety symbols have been placed throughout the guide.



Warnings identify conditions or practices that could result in personal injury.



Cautions identify conditions or practices that could result in damage to the equipment.

SECTION 2 PRE-INSTALLATION CONSIDERATIONS

2.1 EQUIPMENT LOCATION

The MD302 SAM Standby Attitude Module is designed primarily to be installed in the instrument panel of the aircraft. However, within the limitations of the environmental qualifications, other locations may be acceptable when considered with the appropriate installation certification.

The MD302 has an extra-wide viewing angle and AnyWay™ selectable orientation that allows for flexible installation locations and options. The unit can be mounted vertically (knob left or knob right) or horizontally (attitude left or attitude right). During configuration, the display orientation can be selected to match the desired installation. However, when selecting a location to install the MD302, be sure to consider appropriate field-of-view with regard to pilot and/or co-pilot visibility and accessibility. Note: when installing in vertical orientation, choose the knob position based on whether or not the pilot's hand will obscure the display during operation. (Figure 2.1)

Additionally, consider what equipment is behind the panel which may impede the installation of the MD302. Clearance for the unit as well as its electrical and pneumatic connections and routing must be allowed. Be aware of routing cables near other electronics or with other wire bundles that may be susceptible to high energy flow. Avoid sharp bends in cabling or hoses and routing near aircraft control cables. Also, avoid proximity and contact with aircraft structures, avionics equipment, heat sources or other obstructions that could chafe or damage wires or hoses during flight and cause undesirable effects.

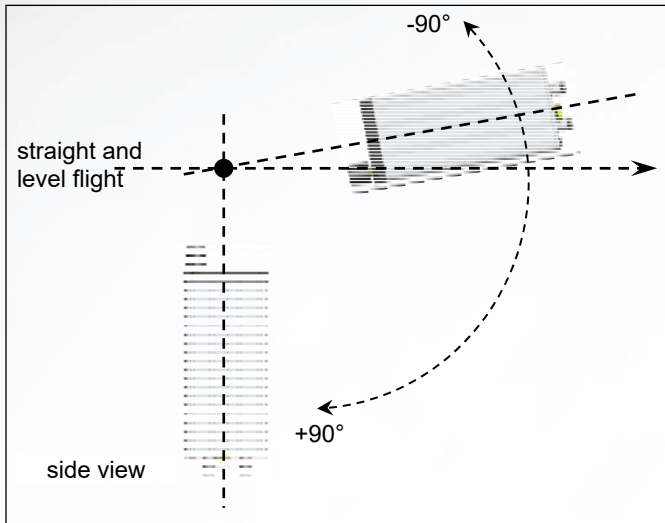

Panel tilt: -90° to $+90^{\circ}$
(horizontal shown; also applicable for vertical)

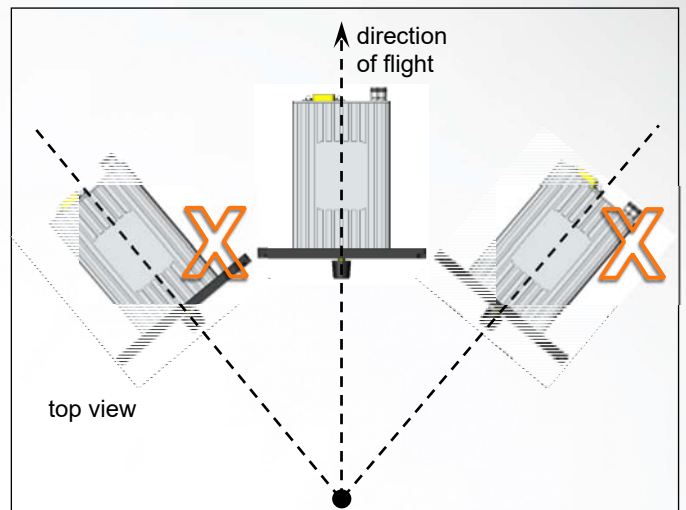

MUST BE INSTALLED IN THE DIRECTION OF FLIGHT



VERTICAL, KNOB LEFT



VERTICAL, KNOB RIGHT



HORIZONTAL, ATTITUDE LEFT



HORIZONTAL, ATTITUDE RIGHT

**FIGURE 2.1
INSTALLATION ORIENTATION OPTIONS**

2.2 LIMITATIONS

The conditions and tests for TSO approval of this article are minimum performance standards. Those installing this article on or in a specific type or class of aircraft must determine that the aircraft installation conditions are within the TSO standards, specification of the article, and deviations listed below. TSO articles must have separate approval for installation in an aircraft. The article may be installed only according to 14 CFR Part 43 or the applicable airworthiness requirements.

There are some portions of the approved TSOs which represent outdated requirements or do not apply to the product. These items are highlighted below and have been submitted to and approved by the FAA as deviations to the TSO certifications of the product. In the case of FAA TSO and EASA ETSO-C3e and C6e, the MD302 has been approved as an “incomplete TSO”. For C3e The MD302 meets all TSO requirements for applicable functions (slip) but does not meet the display requirements for rate of turn. A note below describes further details regarding the temperature requirements of FAA TSO-C113a, but does not represent a deviation.

Where applicable, the environmental qualification requirements and test procedures identified within the TSOs have been superseded by the procedures of RTCA/DO-160, Revision G.

FAA TSO-C2d: Airspeed Instruments

- instrument is not labeled with “Airspeed” or “IAS”

FAA TSO-C3e: Turn and Slip Instrument - (incomplete)

- instrument does not provide rate-of-turn display

FAA TSO-C4c: Bank and Pitch Instruments

- dielectric strength/insulation resistance does not apply due to electronic components between chassis and connector pins

FAA TSO-C6e: Direction Instrument, Magnetic (Gyroscopically Stabilized) – (incomplete)

- instrument meets requirements for displaying heading
- requires external source to provide heading data

FAA TSO-C10b: Altimeter, Pressure Actuated, Sensitive Type

- instrument is not labeled with “Altitude” or “ALT”
- graduation increments are every 25 feet instead of 20 feet
- altimeter accuracy may be reduced when operating below -30°C (contact manufacturer for additional information)

FAA TSO-C113a: Airborne Multipurpose Electronic Displays

- For units prior to MOD 2, the display is operable but marginally usable at -30°C. Display is fully functional at temperatures higher than -30°C.
- units incorporating MOD 2 have a built-in heater to provide full display visibility within 5 minutes of applying power at -45°C

2.3 MODIFICATION

This product has a nameplate that identifies the manufacturer, part number, description, certification(s) and technical specifications of the unit. It also includes the “MOD” or modification number representing notable changes in the hardware design of the unit.

Modification (MOD) 0 is the initial release of the product and is identified on the nameplate by the lack of marking on the MOD numbers 1 through 9 (i.e. 1-9 are visible). All subsequent modifications are identified on the nameplate by the marking/blacking out of that particular MOD number (i.e. for MOD 1, the number 1 is not visible and 2-9 are visible - see Figure 2.2 for examples). MODs do not have to be sequentially inclusive and may be applied independent of each other.

For additional details regarding specific changes associated with each MOD status refer to the product published Service Bulletins at www.mcico.com or www.flysam.com.

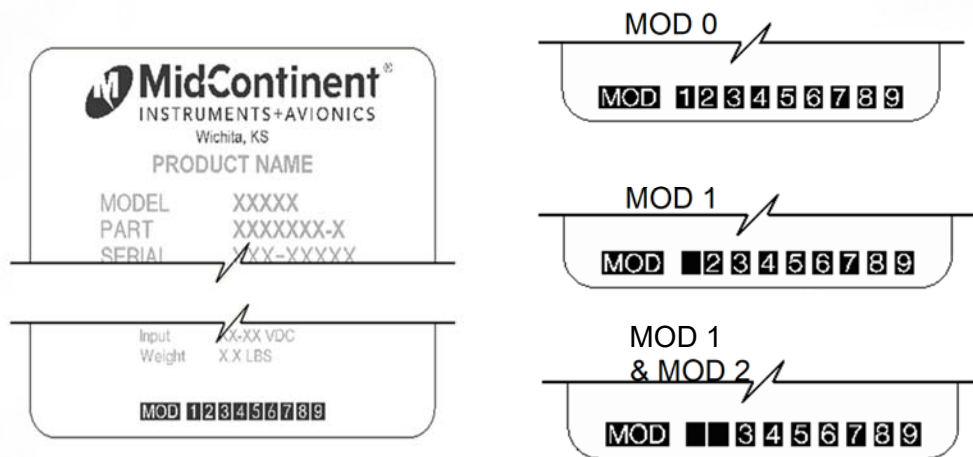

Figure 2.2
Nameplate and MOD Status Example

SECTION 3 INSTALLATION

3.1 GENERAL INFORMATION

This section contains interconnect diagrams, mounting dimensions and other information pertaining to the installation of the MD302 SAM Standby Attitude Module. After installation of cabling and before installation of the equipment, ensure that power is applied only to the pins specified in the interconnect diagram.

3.2 PARTS LIST

When unpacking this equipment, make a visual inspection for evidence of any damage that may have incurred during shipment. The following parts should be included:

<u>Item Description</u>	<u>MCIA Part Number</u>
a. MD302 SAM Standby Attitude Module	6420302-()
i. Internal/Replacement Battery Pack (Installed on select versions)	9017177 (Type 1) 9019120 (Type 2)
ii. Included/Replacement O-rings	9017146
b. Installation Manual	9017782
c. Connector Kit	9017646
i. Nutplate	9017490-2
ii. Pneumatic Connector (x2)	9017642
iii. Screw, Hex, 6-32x5/8 (x4)	90-620-52011
iv. Screw, Flat, 2-56x1/4 (x2)	90-208-10011
v. Configuration Module	9017275
1. 15-pin D-Sub	
2. Backshell	
3. Backshell Cover	
4. Printed Circuit Board Assembly	
5. Screw, Flat, 2-56x1/4 (x2)	
6. Screw, 4-40x3/16 (x4)	
7. Screw, 2-56x3-16 (x2)	

3.3 CABLE HARNESS

Construct the cable harness in accordance with the instructions below including the Connector Pinout of Table 3.1 and Figure 3.1 and Configuration Module Assembly of Figure 3.2. Installers should follow industry-accepted practices regarding aircraft wiring and applicable regulatory requirements and guidance. The instructions for constructing the cable harness as listed within this manual were also used to construct the harness during environmental and electrical testing. Alterations may invalidate environmental qualification and/or performance results.

Refer to Section 2.1: Equipment Location for routing precautions.



3.3.1 Wire Gauge Selection

Wire gauge should be 22 AWG. Use of PTFE, ETFE, TFE, Teflon, or Tefzel insulated wire is recommended for aircraft use per MIL-DTL-16878 or equivalent. Additionally, for data signals associated with ARINC 429 inputs and outputs, shielded twisted pair wiring per M27500 or equivalent is recommended (pin pairs 3 & 8 and 12 & 13).

3.3.2 Configuration Module

The supplied custom configuration module is required for proper installation and operation of the unit. The functions associated with the 15-pin D-subminiature connector are identified as follows:

Unit Connector Pin Identification				
Pin No.	Description		Pin No.	Description
1	+10-32VDC Input		9	ARINC In #2 (A)
2	Valid Signal Out		10	Config Module Clock
3	ARINC Out B		11	MD32 Power Out
4	ARINC In #2 (B)		12	ARINC In #1 (A)
5	Config Module Power		13	ARINC In #1 (B)
6	Power Return / Ground		14	Config Module Data
7	Lighting Bus Input		15	Config Module Return
8	ARINC Out A			

TABLE 3.1



FIGURE 3.1
VIEW FROM REAR OF MATING CONNECTOR



To assemble the aircraft cable harness and Configuration Module refer to the following instructions and Figure 3.2:

- 1) Install a pin/socket as supplied in the Connector Kit using an appropriate crimping tool for each wire in the aircraft cable harness. Be sure to make the harness long enough to remove the unit from the front of the panel without stressing the harness (approx. 8" longer than required to reach the unit connector).
- 2) Braids from shielded wires should be separated from the wire conductors and pulled back from the pin/socket termination approximately 2" and gathered together.
 - i. NOTE: Additional chafe protection, such as heat shrink or nylon wire braid is recommended over the bundle (not including the shields) to prevent wear when installed in the cable clamp.
- 3) Insert the pins of the cable harness into the rear of the 15-pin D-Sub connector (Item 4) per Table 3.1 and Figure 3.1 using an appropriate pin insertion tool.



CAUTION: The Configuration Module PC Board Assembly contains sensitive electronics that can be damaged by electrostatic discharge (ESD). Appropriate precautions should be applied prior to handling this component.

- 4) Insert the pins of the Configuration Module PC Board Assembly (Item 3) into their corresponding locations as noted below using an appropriate pin insertion tool.
 - a. The wires coming from the Configuration Module PC Board Assembly are marked as follows on the circuit board: TP1, TP2, TP3, TP4.
 - b. With the D-Sub oriented up (pin locations 1-5 on top), orient the Configuration Module PC Board Assembly with the electronic parts facing UP prior to pin insertion.
 - c. Install each pin into the rear of the D-Sub connector as follows:
 - Board TP1 = config return = D-Sub pin 15
 - Board TP2 = config data = D-Sub pin 14
 - Board TP3 = config clock = D-Sub pin 10
 - Board TP4 = config power = D-Sub pin 5
- 5) Install the D-Sub Backshell Spring (Item 5) as shown.
- 6) Place the D-Sub Slide Lock (Item 6) over the D-Sub connector.
- 7) Install the D-Sub connector with Slide Lock and cable harness attached into the Backshell (Item 1) and secure with (2) screws (Item 8). Verify that the Backshell Spring is between the Slide Lock and Backshell. Move the Slide Lock back and forth to verify free movement.
- 8) Route the aircraft wire harness bundle (excluding shield braids) between the two halves of the Cable Strain Relief Clamp (Item 7). The Clamp should be placed over the chafe protection installed in Step 2 (if used).

- 9) Loosely connect the two halves of the Cable Strain Relief Clamp with (2) screws (Item 8).
- 10) Place the Cable Strain Relief Clamp in the Backshell as shown.
- 11) Bend the wires of the Configuration Module PC Board Assembly 180 degrees so that the PC Board has its electrical components facing down as shown. Be careful not to place excess strain on the solder connections between the wires and the PC Board.
- 12) Capture the Configuration Module PC Board Assembly into the Backshell by placing the Backshell Cover (Item 2) on top of the Backshell.
- 13) Secure the Backshell Cover onto the Backshell using (2) Screws (Item 9).
- 14) Bundle the exposed shield braids and secure them to either threaded hole on the rear of the Backshell using a 2-56 screw (Item 10). A wire that is common to aircraft chassis ground shall also be connected to one of these two holes on the Backshell. Use of a ring terminal (not included) may be useful.
- 15) The completed assembly should look as shown. Verify that the Slide Lock operates freely and that no wires are pinched, nicked, or otherwise damaged.
- 16) Verify that power and ground signals are installed appropriately before connecting to the unit.

3.4 PITOT / STATIC CONNECTIONS

The connector kit supplied with the unit contains two (2) pneumatic quick disconnect fittings. These fittings are specific to the connections on the rear of the unit and required for proper operation.

Aircraft tubing that connects to the unit must be ¼" OD with an approximate 0.17" ID. When determining tubing length, be sure that it can extend through the cutout in the panel by approximately 8" to allow the unit to be installed and removed from the front of the panel.

If o-rings are worn or damaged, replace with MCIA p/n 9017146 and install per the drawing as shown.

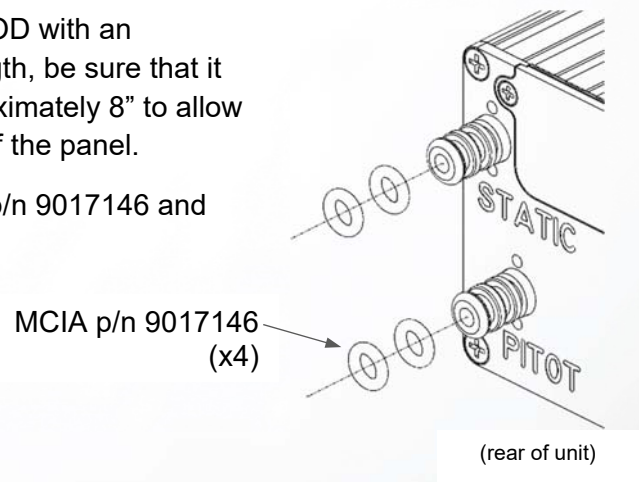

NOTE: It is helpful to identify/label each tube (pitot or static) so that it can be connected to the correct port on the back of the unit during installation.

CAUTION: Lock quick disconnect before connecting to the unit to avoid damaging the O-ring.



Item	Qty	Part Number	Description
1	1	9017218	Backshell, Size 9
2	1	9017274	Cover, Backshell
3	1	9017184-1	PCB Assy, Config Module
4	1	9016479	Kit, DSub, 15pin HD
5	1	part of 9016479	DSub Backshell Spring Clip
6	1	part of 9016479	DSub Slide Lock, Size 9
7	2	part of 9016479	DSub Backshell Cable Clamp
8	4	90-406-00011	Screw 4-40X3/16 Pan Phil Blk Patch
9	2	90-208-10011	Screw 2-56X1/4 Flat Phil Blk Patch
10	2	90-206-00011	Screw 2-56X3/16 Pan Phil Blk Patch

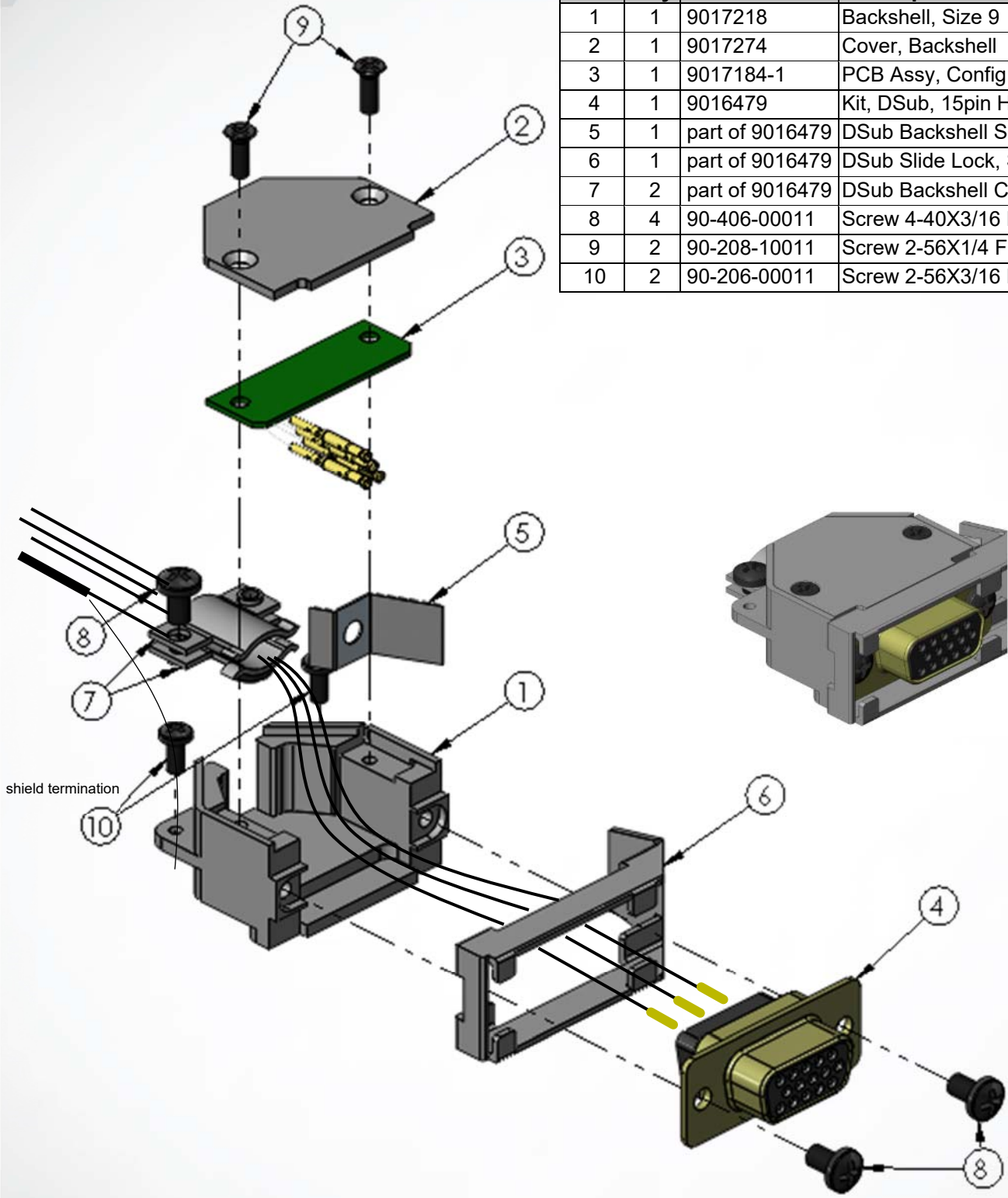

FIGURE 3.2
CONFIGURATION MODULE ASSEMBLY

3.5 MOUNTING

The MD302 is designed primarily to be front mounted in an aircraft instrument panel. Refer to Section 2.1 for Equipment Location information. To install the unit in the instrument panel, follow the instructions below and refer to Figures 3.3, 3.4 and 3.5.

- 1) Once a location is selected, cut the panel per the dimensions in Figure 2.6. Other notes to consider for panel cutout: (the Nutplate can be used as a basic template for the panel cutout)
 - For vertical installation, rotate the panel cutout profile 90°.
 - Be sure to leave space clear on the front of the panel for the bezel of the unit, which will extend significantly outside the main rectangular cutout.
 - The dimension of the smaller side of the rectangle is critical for a good finished appearance. If it is too large, the cutout will be visible outside the unit bezel. The relationship of the holes to the cutout should be maintained closely to ensure proper installation.
 - One countersink hole on either side of the rectangular cutout is required. Any of the three hole locations is acceptable. More than one countersink hole on each side is optional. Screws for these holes will retain the Nutplate and not support the weight of the unit.
 - Verify that a flathead screw will sit flush or below the panel surface in the countersink holes. If not, deepen the countersinks slightly.
 - Remove burrs around the cutout and holes to allow the unit to mount flush with the panel.
- 2) Install the Nutplate on the backside of the instrument panel using at least one (1) flathead screw on each side of the rectangular cutout.
 - The Nutplate should mount flush to the backside of the instrument panel. The threaded nuts in corners of the Nutplate should protrude to the rear.
- 3) Route the prepared cable harness and pitot/static fittings from behind the panel and through the panel cutout. The length of the cable harness should allow the unit to be connected in front of the panel.
- 4) VERIFY THAT AIRCRAFT POWER IS TURNED OFF.
- 5) Connect the cable harness with Configuration Module and pitot/static fittings to the rear of the unit.
- 6) Insert the unit through the panel cutout and secure with four (4) hex head cap screws provided.
 - Electrical bonding between the aircraft and the unit chassis is NOT required.

3.6 INSTALLATION COMPLETION

Prior to operating the unit in the aircraft, verify the basic operation of the unit and conduct a standard leak check of the pitot/static system per the aircraft maintenance manual or industry practice. When initially powering the unit, an error may occur if a pre-configured unit is being mated to a Configuration Module for the first time or if the unit has yet to be configured. Acknowledge this error and either proceed to configuring the installation settings or cycle the power. The error should not occur for subsequent startups.

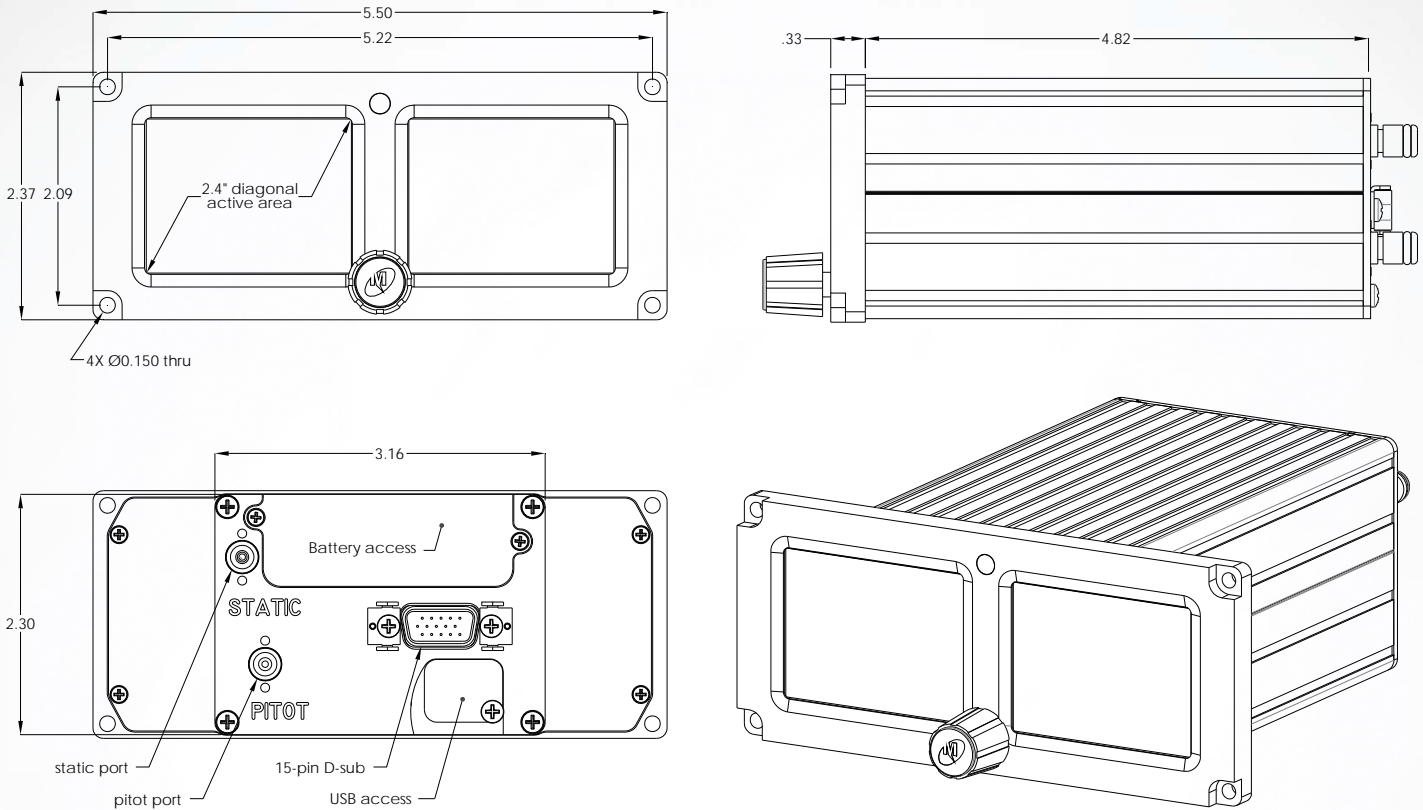

FIGURE 3.3
MD302 OUTLINE DRAWING

SAM®

Standby Attitude Module

Unit Versions		
Part Number	Bezel	Battery
6420302-1	Black	Type 1
6420302-2	Black	None
6420302-3	None*	None
6420302-4	Gray	Type 1
6420302-5	Gray	None
6420302-6**	Black	None
6420302-7	Black	Type 2
6420302-8	Gray	Type 2

* Remote mounted unit version. Contact manufacturer for details.
**Non-standard version

TABLE 3.2
MD302 UNIT VERSIONS

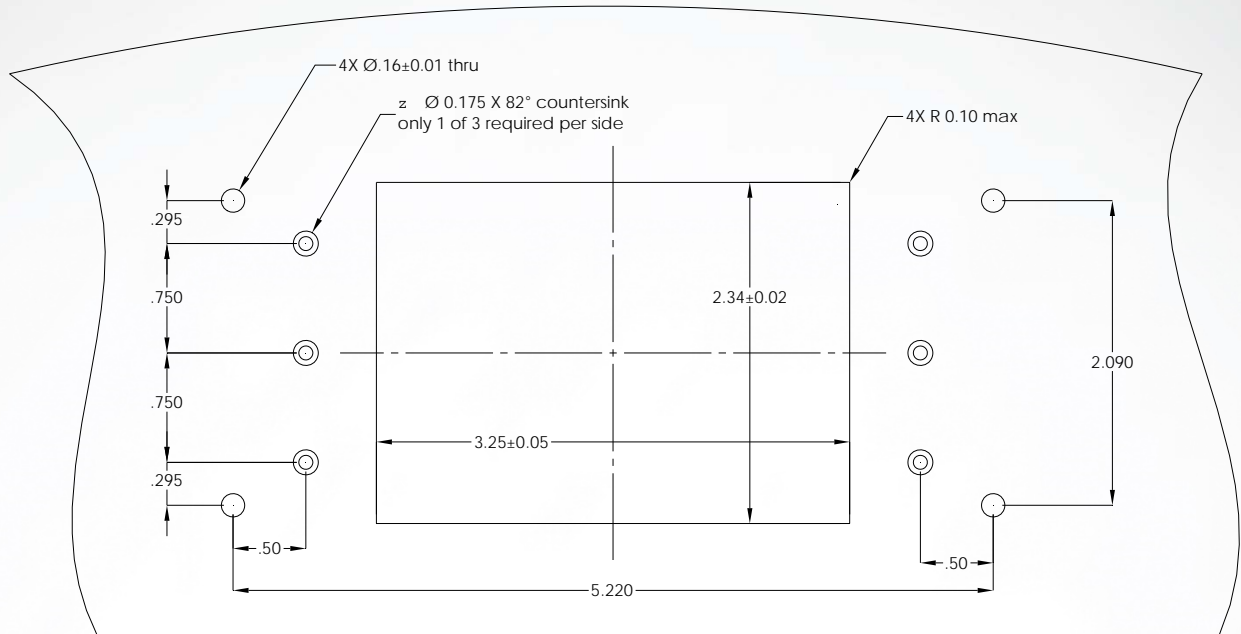

**FIGURE 3.4
PANEL CUTOUT**

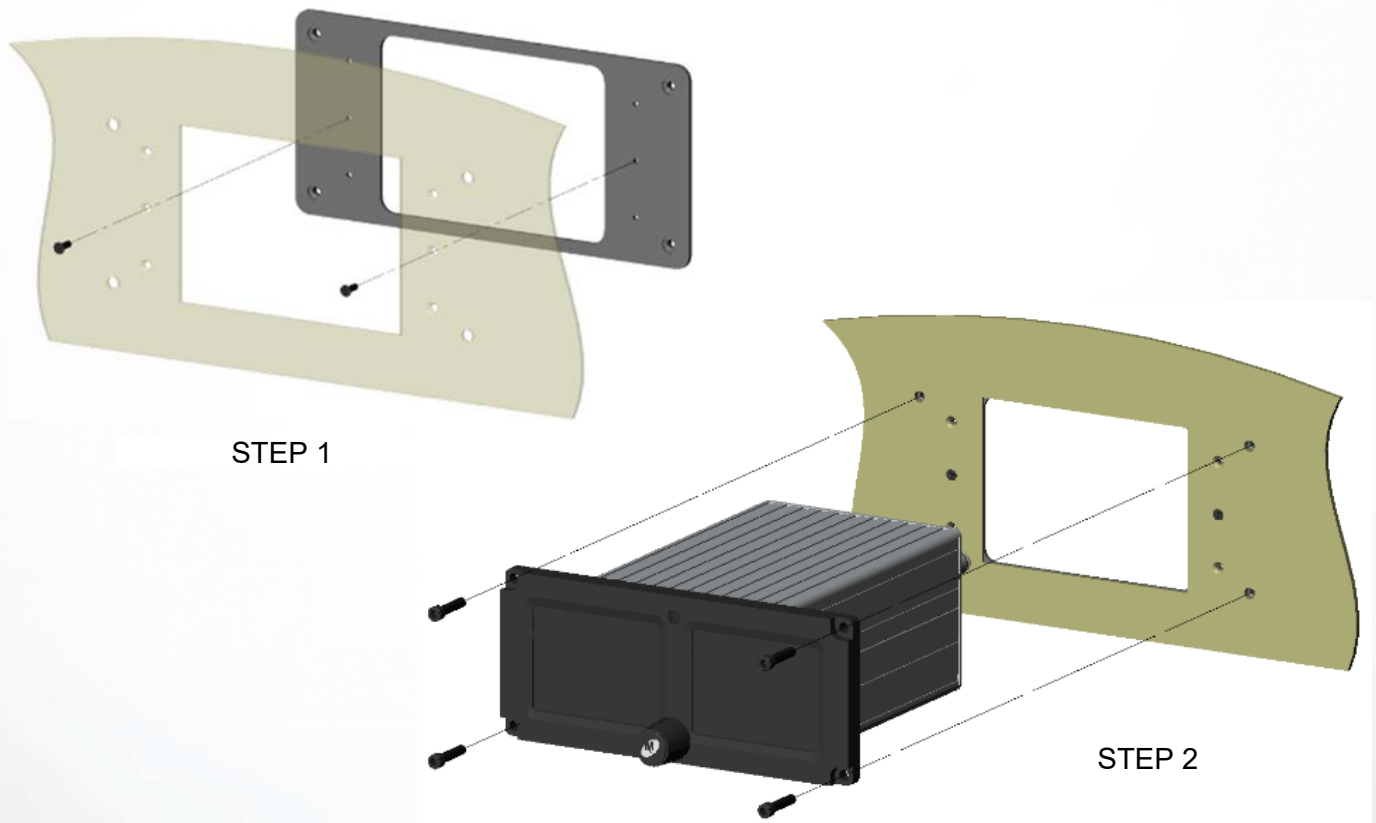

**FIGURE 3.5
INSTALL ILLUSTRATION**

SECTION 4 OPERATION

IMPORTANT: READ THIS ENTIRE SECTION PRIOR TO STARTING INSTALLATION!

The MD302 has four specific modes of operations:

- Pre-flight Mode - Section 4.2
- Flight Mode - Section 4.3
- Emergency Operation - Section 4.4
- Configuration Mode - Section 4.5

This section contains information on how to use and interpret the information presented to the pilot and crew during normal and emergency operation of the MD302 SAM Standby Attitude Module.

4.1 USER INTERFACE

The MD302 SAM Standby Attitude Module is designed for simple, intuitive operation for ease of use and quick interpretation of the information displayed.

The central control knob can be located at the bottom-center, middle-left or middle-right of the unit bezel depending on the installation orientation. This is the only user interface on the unit.

The knob has two functions: push and turn.

- The knob provides 16-detents per revolution and typically increments whatever element it is controlling on the display one unit per detent.
- The push function is typically used to select the highlighted option in a menu and/or to enter and exit menus and control functions. The push function can also perform certain operations with a push-and-hold action as described herein.

4.2 PRE-FLIGHT MODE

In Pre-flight Mode, power is applied to the unit and the introduction screen appears during startup. (Figure 4.1) The startup screen will display the manufacturer's logo, model name and number, SSEC identifier (if present), software version and total operating time.

During Pre-flight Mode, the introduction screen will be displayed while the unit conducts an initial power-up built-in test (PBIT) of the system to validate operational readiness. This includes, among others, a battery capacity measurement, an internal test to verify software and memory, and a check that the internal settings and identification of the unit match the Configuration Module installed in the aircraft cable harness.



The introduction screen will be displayed for approximately five seconds and will transition to Flight Mode when complete.

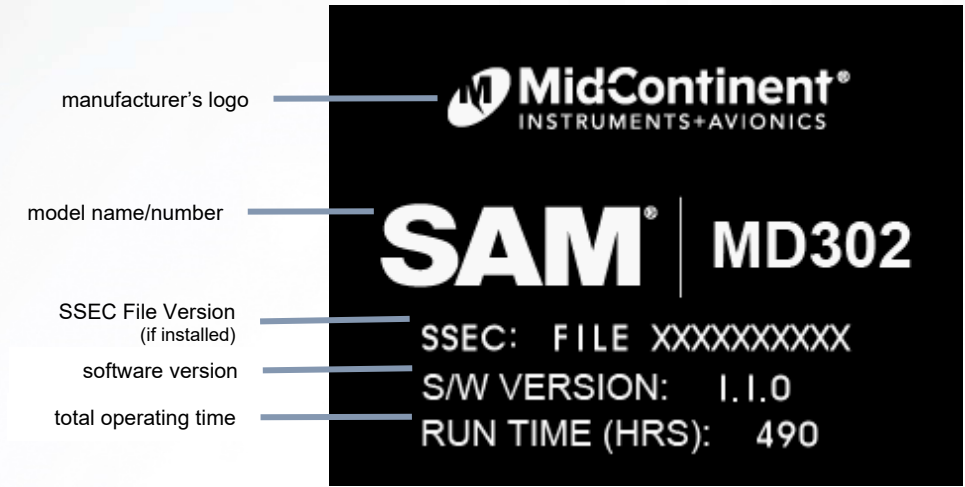

Figure 4.1
PRE-FLIGHT MODE

4.3 FLIGHT MODE

In Flight Mode, the unit operates normally by displaying attitude, altitude, airspeed, heading (optional), and slip information. The Options Menu and brightness adjustment are also accessible in Flight Mode. (Figure 4.2)



Figure 4.2
FLIGHT MODE

4.3.1 Functions

While in Flight Mode, the MD302 provides up to five functions: attitude, altitude, airspeed, heading (optional), and slip indication. (Figure 4.2)

4.3.1.1 Attitude Operation

The attitude indicator portion of the display can be configured on the right or left when mounted horizontally and is always on the top display when oriented vertically. (Figure 2.1)

The background of the display consists of the representative white horizon line separating the 'sky' (blue) and 'ground' (brown).

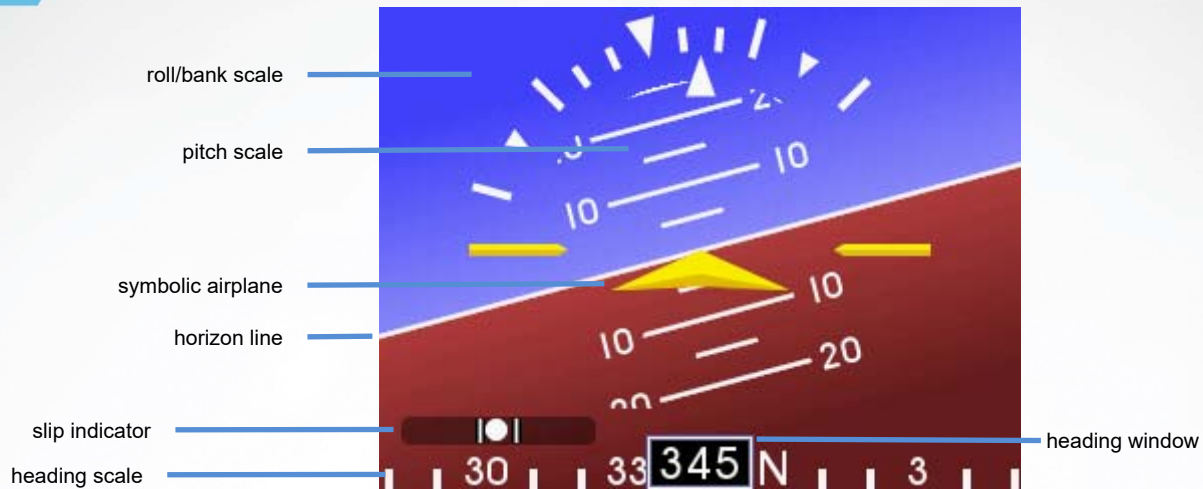

Figure 4.3
ATTITUDE OPERATION

The roll scale is depicted as an arc of graduations representing bank angles of 0 (triangle), 10, 20, 30, 45 (small triangle), and 60. The roll scale can be configured during installation to be fixed to the sky/horizon or fixed to the top of the display. See 0 for how to configure this option. The unit is operable and usable in a continuous and unlimited roll range of 360°+.

The roll pointer is the triangle just below the roll scale and represents the aircraft in relation to its bank angle. It is configured, by definition, to operate conversely to the roll scale behavior. That is, a rotating roll scale produces a fixed roll pointer and a fixed roll scale produces a rotating roll pointer.

The pitch scale is depicted as a series of graduations representing pitch angles of every 5°, with every 10° graduation extended and numbered. The unit is operable and usable in a continuous and unlimited pitch range of 360°+. A series of chevrons (^) will appear overlaid on the pitch scale when in extreme pitch attitude. This is to indicate to the pilot the direction of the horizon for quick reference. (Figure 4.4)



Figure 4.4
ATTITUDE OPERATION: EXTREME PITCH

The symbolic airplane will always remain in the center of the display, with the background elements moving behind it to represent the aircraft's relative position. The symbol that represents the airplane can be selected during Flight Mode using the Options Menu. (see Section 4.3.2)



4.3.1.2 Heading Operation

The configurable heading indicator is comprised of a window showing the current heading in degrees and a moving tape/heading scale along the bottom of the display. (Figure 4.5)

Heading operation can be enabled in configuration mode (See Section 4.5 Configuration Setup).

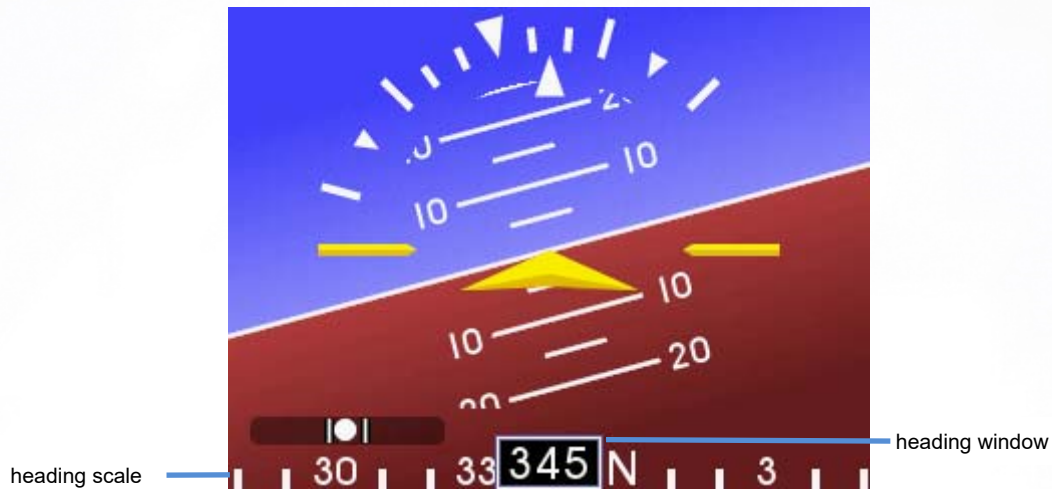

Figure 4.5
HEADING OPERATION

The heading scale is depicted with cardinal letters (N, S, E, W) every 90°, numerals every 30° between cardinal headings, and graduations every 10° elsewhere. Degree numbers do not show the trailing zero (i.e. 30° = 3, 300° = 30, etc).

The heading window displays three digit heading in degrees. This heading is gyroscopically stabilized and synchronized to input data received via ARINC 429 from the installed MD32 Remote Magnetometer (priority 1) or an external source (such as a PFD/AHRS system - priority 2 if both are installed). If MD32 or ARINC heading reference is lost the display will run without magnetic reference (gyroscopically) for 10 seconds before changing to display “---”. The source of the heading data is indicated by the presence or direction of the arrows next to the three-digit heading display. (Figure 4.6)

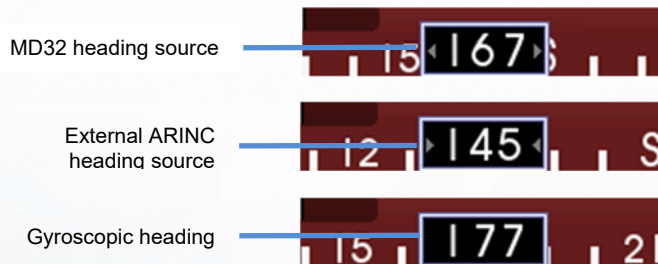

Figure 4.6
ARINC HEADING SOURCE

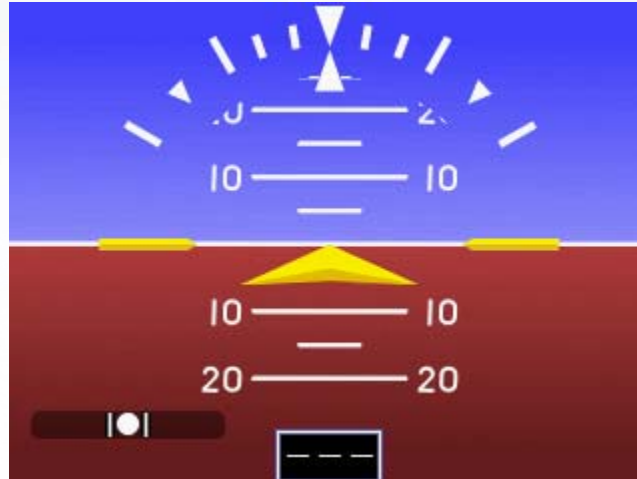

Figure 4.7
ARINC HEADING DATA LOSS

4.3.1.3 Slip Operation

The slip indicator portion of the display will appear at the bottom of the attitude display (see Figure 4.4). If heading is enabled, the slip indicator portion of the display will appear above and to the left of the heading window (Figure 4.5).

The slip indicator is represented by a shaded translucent background with two white lines around center and a white ball. When the ball is maintained between the vertical lines during banking maneuvers, the turn is considered “coordinated” without slip. Electronic damping of the ball movement is provided to prevent overly sensitive response and comply with regulatory requirements.

4.3.1.4 Altitude Operation

The altimeter portion of the display will always appear on the right side of airspeed/altitude display. (Figure 4.8)

The altimeter consists of four parts: the altitude window, the altitude tape, the barometer window, and the optional altitude trend bar.

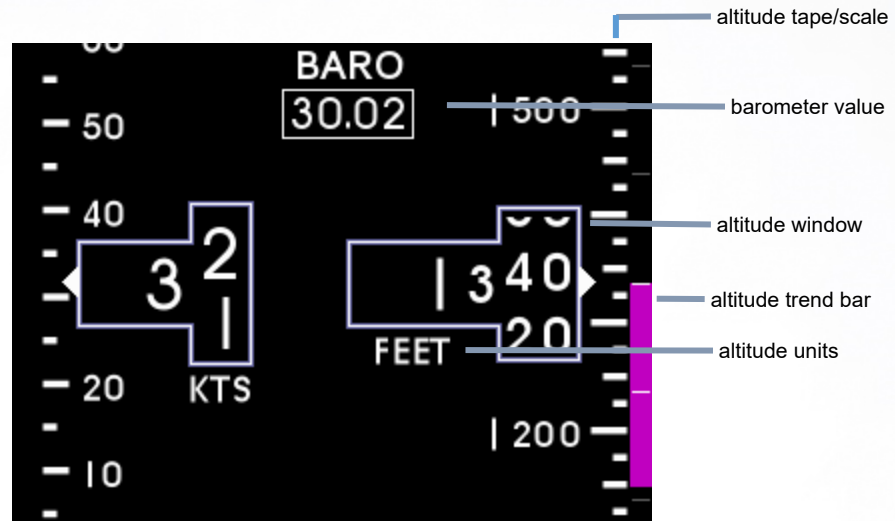

Figure 4.8
ALTITUDE OPERATION

The altitude window displays the current, barometric corrected altitude. The indicated digits of the display are every twenty (20) units and the window is expanded over this portion of the number to display a minimum of forty (40) units. The units will 'roll' or scroll to assist in quick reference as to the increasing or decreasing nature of the aircraft's altitude. The hundreds, thousands and ten-thousands digits appear to the left of the tens digits with the thousands and ten-thousand digits slightly larger than the others. The altitude pointer (triangle) to the right of the window points to the associated position on the altitude tape of the current altitude. Altitude units appear below the altitude window and can be changed during Flight Mode using the Options Menu (see Section 4.3.2).

The altitude tape is a vertical scale along the right margin of the display. The current altitude is always in the middle of the tape and indicated by the triangular pointer on the right side of the altitude window. The tape has numeric indications every one-hundred (100) units with minor graduations every fifty (50) units and sub-graduations every twenty-five (25) units. In horizontal installations, the tape spans approximately four-hundred (400) units from top to bottom and in vertical installations, the tape spans approximately five-hundred (500) units from top to bottom. The tape will 'roll' or scroll to for quick reference as to the increasing or decreasing nature of the aircraft's altitude.



The barometer window shows the currently set barometric pressure located at the top center of the airspeed/altitude display and is identified by the abbreviation “BARO”. Setting the current barometric pressure compensates the altitude for the appropriate environmental conditions. The barometric setting can be synchronized externally to an ARINC 429 source that supplies data labels 203 and 204 (typically the aircraft’s primary flight display (PFD)). When the barometric setting on the PFD is changed, the MD302 will change to match. When the two are synchronized, the barometric window will display two arrows, located on either side of the word “BARO” (Figure 4.9). Manually changing the MD302 barometric setting will override the external source, however, when the external barometric setting of the source changes, the MD302 will re-synchronize to the source. The barometric setting can be manually adjusted by simply turning the control knob while in Flight Mode. When the barometric pressure is adjusted externally or manually, the window and digits will turn green (Figure 4.10). When finished setting the pressure, the window and digits will return to their original color. Barometric pressure units can be selected during Flight Mode using the Options Menu (see Section 4.3.2).

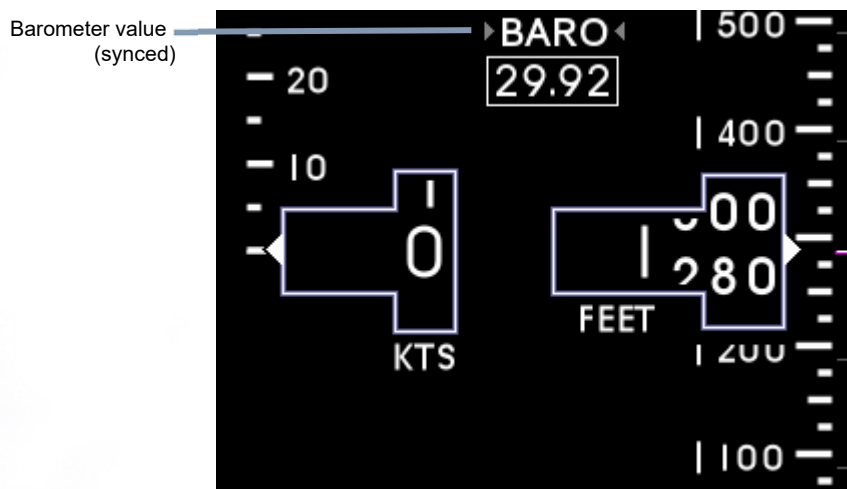

Figure 4.9
ALTITUDE OPERATION: BARO SYNCHRONIZATION

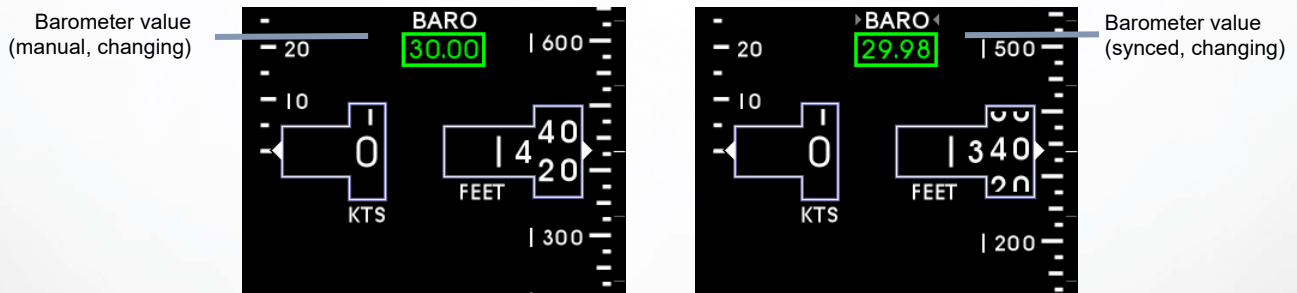

Figure 4.10
ALTITUDE OPERATION: BARO CHANGE

4.3.1.5 ALTITUDE TREND

The altitude trend bar is located along the right margin of the altitude display. This feature is optional and can be turned on or off using the Options Menu (see Section 4.3.2). The trend bar is magenta in color and originates at the current altitude on the altitude tape (always from the middle of the display, directly across from the altitude pointer). The height of the trend bar, above or below the current altitude, indicates the altitude of the aircraft on the altitude tape if the current vertical speed or 'altitude trend' is maintained over a period of six (6) seconds. For example, in Figure 4.11, the current altitude is approximately 1,340 feet. The trend bar is at approximately 1,150 feet, indicating that the aircraft's altitude will be 1,150 feet in 6 seconds if the current vertical speed or climb is maintained constant. The length of the trend bar will increase with increased dive or climb rates and approach zero or disappear entirely as the vertical speed reaches zero in level flight.

4.3.1.6 AIRSPEED OPERATION

The airspeed indicator portion of the display will always appear on the left side of the airspeed/altitude display. (Figure 4.11)

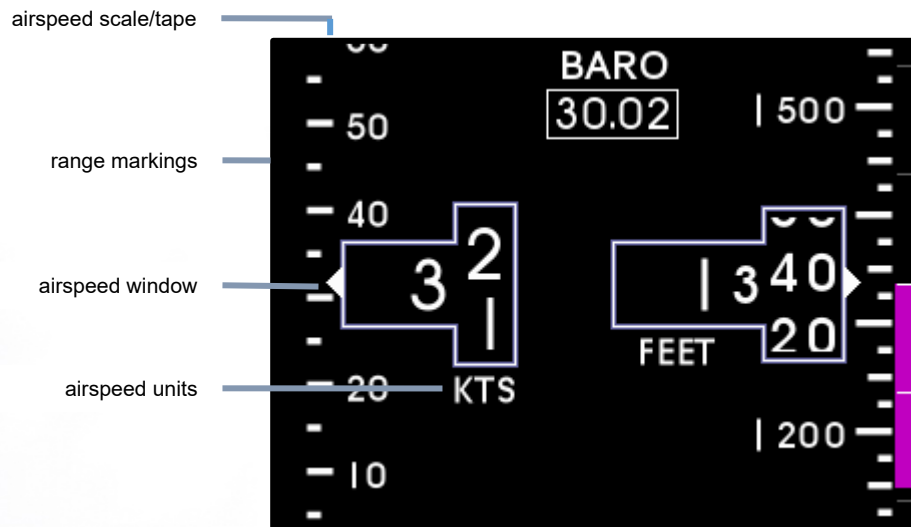

Figure 4.11
AIRSPEED OPERATION

The airspeed indicator display consists of three parts: the airspeed window, the airspeed tape and the airspeed limitations or range markings.

The airspeed window displays the current indicated airspeed (IAS). The digits of the display are enlarged for visibility and increment by one (1) unit. The units will 'roll' or scroll to assist in quick reference as to the increasing or decreasing nature of the aircraft's airspeed. The airspeed pointer (triangle) to the left of the window points to the associated position on the airspeed tape of the current airspeed. Airspeed units appear below the airspeed window and can be selected during installation in Configuration Mode (see Section 4).



The airspeed tape is a vertical scale along the left margin of the display. The current airspeed is always in the middle of the tape and indicated by the triangular pointer on the left side of the airspeed window. The airspeed tape has numeric indications every ten (10) or twenty (20) units depending on the unit type selected. Minor graduations appear every five (5) or ten (10) units, respectively. In horizontal installations, the tape spans approximately fifty (50) or one-hundred (100) units from top to bottom and in vertical installations; the tape spans approximately eighty (80) or one-hundred sixty (160) units from top to bottom depending on unit type. The airspeed tape will 'roll' or scroll to assist in quick reference as to the increasing or decreasing nature of the aircraft's airspeed.

The airspeed limitations, also known as "V-speeds" or range markings, are indicated with colored bands placed vertically along the left margin next to the airspeed tape. The colors and values of each bar can be set during installation in Configuration Mode (see Section 4). Colors should be selected based on industry-defined colors and V-speed limits as defined by the aircraft's specific Pilot's Operating Handbook (POH). Range markings are represented by full-width bars, half-width bars and/or radial marks. A traditional 'barber pole' may also be displayed if required by the aircraft and provides the appropriate V_{NE} , V_{MO} and/or M_{MO} values

4.3.2 Options Menu

While in Flight Mode, the OPTIONS MENU is available to the pilot or cockpit crew members. The Options Menu offers multiple selections that are available during flight but do not affect the aircraft specific configuration of the unit (these must be set in Configuration Mode by authorized personnel during installation and/or maintenance). These options are provided for convenience, preference or potentially necessary in-flight adjustments.

THE OPTIONS MENU can be accessed by pushing and holding the control knob for approximately two (2) seconds. The brightness adjustment bar will appear briefly before the menu is visible. The menu will appear in place of the attitude display and will revert to the active attitude display if no activity occurs for ten (10) seconds. The menu title displays an indication (>) if there is a sub-menu associated with it.

The Option Menu root menu contains the following options: (Figure 4.12)

- ALT UNITS
- BARO UNITS
- SYMBOL
- ATT MASK
- ALT TREND
- INFO >
- EXIT MENU
- POWER OFF

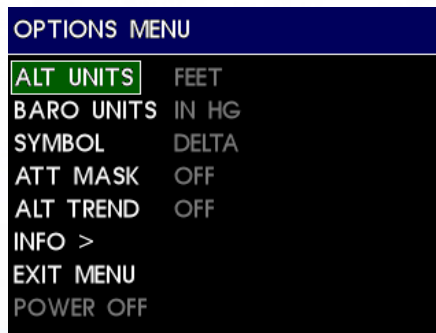

Figure 4.12
OPTIONS MENU

4.3.2.1 Menu Operation

The menu parts are defined below:

Menu Title	White text on a blue background at the top of each menu
Current item cursor	highlighted by a white box and green background
Selectable items	any selectable item on the menu is indicated with white text
Unavailable items	information only / unavailable options are indicated with gray text
>	indicates an item has another menu page associated with it
▲ or ▼	indicates more options available above or below the current list

Menu operation throughout the MD302 is simple and intuitive:

Turning the control knob will scroll the green cursor highlight over the available options within the current menu. By default, the currently set value of each menu option is displayed in gray directly to the right of each setting. Pressing the control knob for any highlighted item will make its options available to the right. Scroll to the desired option and press the control knob to select it. The green highlight will return to the menu options on the left and the new value will be displayed in gray to the right.

After confirming any setting by selecting it, that setting will become immediately active and be saved in memory, regardless of whether the EXIT MENU command is selected or it times out and automatically reverts to the attitude display.

4.3.2.2 Alt Units

The ALT UNITS setting allows the user to select the altitude units to either FEET or METERS. This feature is provided during flight in the event that the aircraft crosses territorial airspace boundaries that require or report different altitude units. (Figure 4.13)



Figure 4.13
ALTITUDE UNITS

4.3.2.3 Baro Units

The BARO UNITS setting allows the user to select the altimeter or altitude barometric adjustment units to either inHg (inches of mercury) or MBAR/HPA (millibars/hectopascals). This feature is provided during flight in the event that the aircraft crosses airspace boundaries that require or report different barometric units. (Figure 4.14)

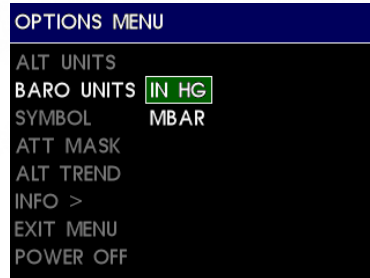
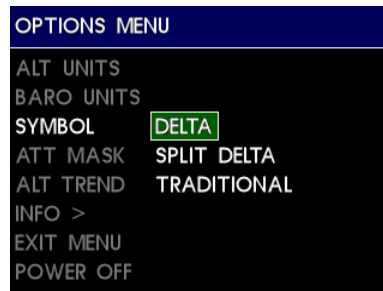

Figure 4.14
BARO UNITS

4.3.2.4 Symbol

The SYMBOL setting allows the user to select the type of symbolic airplane on the attitude display to either DELTA, SPLIT DELTA, or TRADITIONAL. This feature is provided for pilot preference and/or to match other instruments in panel. (Figure 4.15)



DELTA

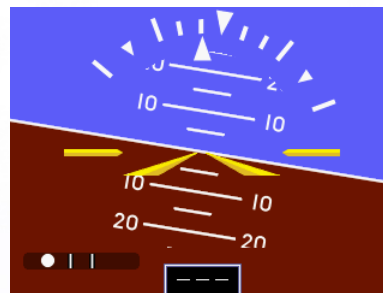

SPLIT DELTA



TRADITIONAL

Figure 4.15
AIRCRAFT SYMBOL OPTIONS

4.3.2.5 ATT Mask

The ATT MASK setting allows the user to turn the attitude mask ON or OFF. The attitude mask provides gradient dimming of the corners of the attitude display to give the aesthetic look of a round instrument. (Figure 4.16)

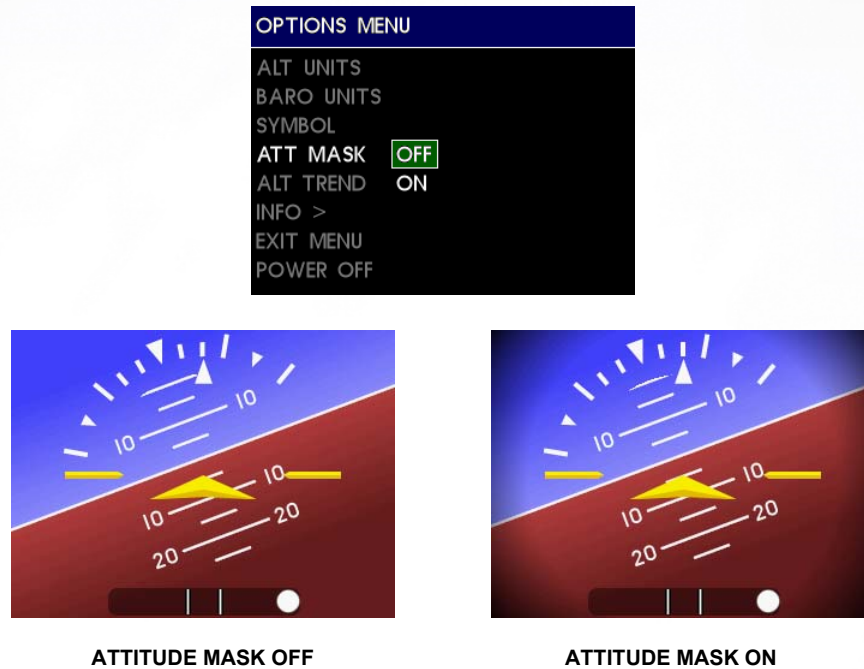

Figure 4.16
ATTITUDE MASK

4.3.2.6 ALT Trend

The ALT TREND setting allows the user to turn the altitude trend bar ON or OFF. The altitude trend bar provides a graphical representation of vertical speed near the altitude tape (see Section 4.3.1.5). This feature is provided for pilot preference and convenience. (Figure 4.17)

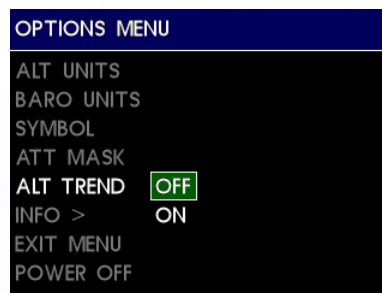

Figure 4.17
ALTITUDE TREND BAR

4.3.2.7 Info >

While in Flight Mode, the INFO menu is available to the pilot or cockpit crewmembers. It offers read-only information available during flight and does not affect the aircraft-specific configuration of the unit.

The INFO> sub-menu contains the following options: (Figure 4.18)

- REVIEW CONFIG
- SOFTWARE INFO
- BATTERY INFO
- EXIT INFO



Figure 4.18
INFO MENU

4.3.2.8 Review CFG

The REVIEW CFG selection allows the user to view all the values saved in unit memory which have been set in Configuration Mode during installation or maintenance. There are no selectable options and this feature provides a read-only verification of information. When selected, the REVIEW CFG screen will appear and allows the user to scroll through all the configuration values. Push the control knob to return to the INFO sub-menu. (Figure 4.19)

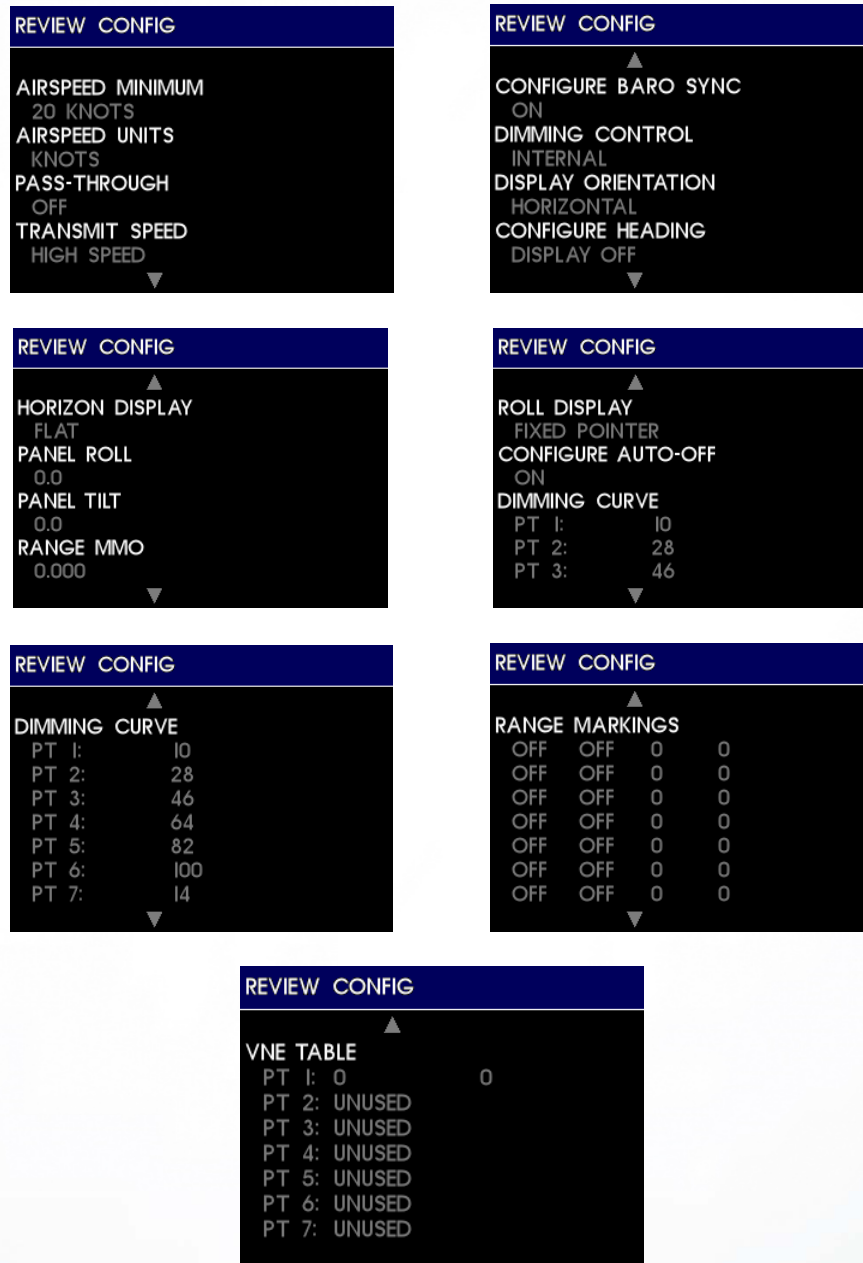

Figure 4.19
REVIEW CONFIGURATION

4.3.2.9 Software Info

The SOFTWARE INFO selection allows the user to view the version of software currently installed on the MD302. If an MD32 remote magnetometer is installed, its software version will be displayed as well. Push the control knob to return to the INFO sub-menu. (Figure 4.20)

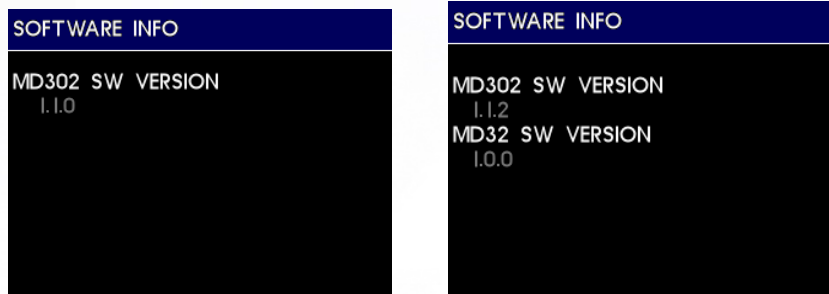

Figure 4.20
SOFTWARE INFO

4.3.2.10 Battery Info

The BATTERY INFO selection allows the user to view real-time status of the internal battery. The information available on a scrollable screen includes the Estimated Run Time in minutes, the Temperature in Celsius, the current Battery State of Charge percentage, the battery Capacity in milliamp-hours and battery Type. Push the control knob to return to the INFO sub-menu. (Figure 4.21)

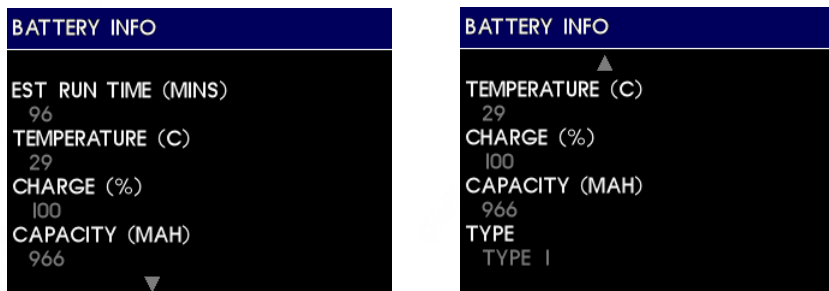

Figure 4.21
BATTERY INFO

4.3.2.11 Exit Menu

The EXIT MENU action allows the user to manually exit the Options Menu and return to the active attitude display. There are no selectable options. After confirming any setting by selecting it, that setting will become immediately active and be saved in memory. This will occur regardless of whether the EXIT MENU command is selected or should it time out after ten (10) seconds of inactivity (and automatically revert to the attitude display). (Figure 4.22)

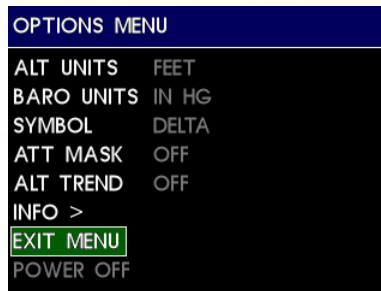

Figure 4.22
EXIT MENU

4.3.2.12 Power Off

The POWER OFF action allows the user to immediately turn the unit off when it is operating on its internal battery. This item is typically grayed out when operating on external/aircraft power. See Section 4.4 for more information on Emergency Operation when operating on battery power. (Figure 4.23)

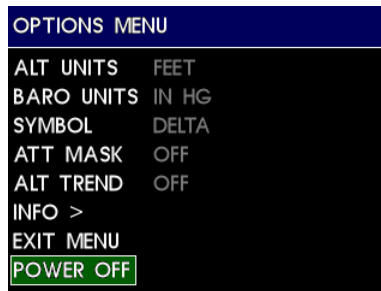

Figure 4.23
POWER OFF

4.3.3 Brightness Adjustment

The MD302 SAM can be configured to adjust its brightness manually, using the aircraft’s lighting bus control, or automatically, based on the ambient lighting conditions sensed by the photocell on the unit. For either option (selected in the Configuration Mode, see Section 4) the pilot or crew member can override the current brightness and manually increase or decrease the brightness. To do so simply press the knob and the brightness bar will appear. The brightness can be increased or decreased by simply turning the knob left or right. (Figure 4.24)

Brightness cannot be reduced below minimum level set in Configuration Mode. To manually adjust the brightness, briefly press the control knob. The brightness bar will appear overlaid on the attitude display and turning the control knob will increase or decrease the current setting. The brightness cannot be turned down below the installation configured minimum.

While the unit remains powered, the manual adjustment will remain saved and any change in the lighting bus or photocell sensor will increase or decrease the brightness from the newly set manual adjustment point.

When the unit is powered off, the manual adjustment will be reset and default to the lighting response curve programmed into memory per the settings in the Configuration Mode setup.



Figure 4.24
BRIGHTNESS ADJUSTMENT

4.4 EMERGENCY OPERATION

4.4.1 In Flight

The MD302 SAM is designed to operate reliably and provide the critical situational awareness needed even if the aircraft power systems fail. Should this occur, the unit provides emergency operation by continuing to perform seamlessly and uninterrupted in Flight Mode.

The MD302 contains an internal and field-replaceable battery which recharges during normal flight, contains a heater for low temperature conditions and provides a minimum of one (1) hour of operation (up to 2.5 hours when new).

If aircraft power to the unit is lost in flight, the unit will immediately begin operating on internal battery power without interruption or pilot intervention. (Unless no airspeed is present – see 4.4.2) This is indicated by a green battery icon displayed in the top right of the attitude display. (Figure 4.25)

When the battery capacity approaches zero during extended use, the battery icon will change to a black battery icon with a red X on it. This indicates that there is less than 20% of battery capacity left and possibly as little as ten (10) minutes of backup power available. (Figure 4.25)

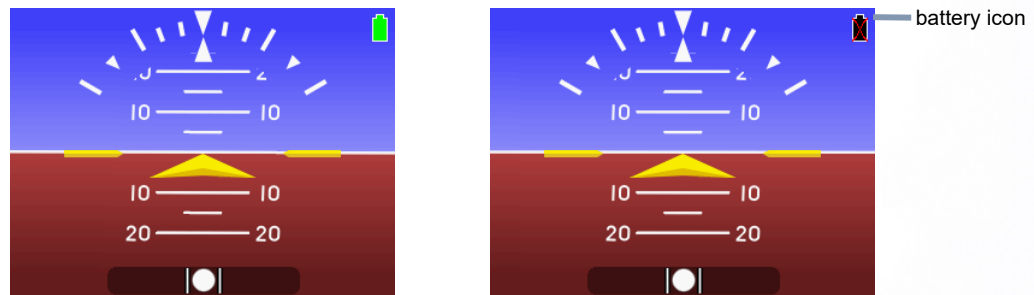

Figure 4.25
EMERGENCY OPERATION

4.4.2 On The Ground

If primary aircraft power to the unit is lost, the unit will immediately and automatically begin operating on internal battery power with no required action. When this occurs as a result of normal landing and shut-down procedures (or hover in a rotorcraft installation), the unit has an Auto-Off feature that will recognize a lack of airspeed and determine that the aircraft is on the ground. The unit will then display a warning message that starts a sixty (60) second countdown. The unit will turn off automatically at the end of the countdown, or the user can choose to manually turn the unit OFF or remain ON by selecting the options on the screen using the control knob. (Figure 4.26)

The Auto-Off feature can also be disabled in Configuration Mode, switching to and maintaining battery power without user acknowledgement, regardless of airspeed. With the Auto-Off feature disabled, the user must manually turn the unit off after each flight.

To manually turn the unit off after while running on battery power, enter the Options Menu and select the POWER OFF action. See Section 4.3.2.12.



Figure 4.26
POWERING DOWN SCREEN

4.5 CONFIGURATION SETUP

IMPORTANT: THE UNIT IS NOT APPROVED FOR FLIGHT UNTIL IT HAS BEEN CONFIGURED FULLY USING THE INSTRUCTIONS IN THIS SECTION!

This section contains information on how to configure the aircraft specific requirements available with the MD302 SAM Standby Attitude Module. In Configuration Mode, an authorized installer can change and set the appropriate configuration values that are specific to the aircraft. This includes critical flight parameters that contribute to the safe and certified operation of the unit and the aircraft as well as user preferences.

Settings found in Configuration Mode are not available during flight. Several safeguards are in place to prevent a user from ever accessing the Configuration Mode while in flight. Only authorized installers and trained personnel should access the Configuration Mode during initial installation or during maintenance, adjustments and updates.

4.5.1 CONFIGURATION MODE/MENU

In Configuration Mode, all of the parameters specific to the aircraft and particular installation are set and saved into memory. These configuration settings are also saved to the external Configuration Module that is part of the aircraft's cable harness. This allows for the unit to be removed and/or replaced for service or other aircraft maintenance and still retain the configuration settings associated with the aircraft.

To enter the Configuration Mode, press and hold the control knob prior to applying power to the unit. After approximately six (6) seconds, the following message will appear: "CONTINUE HOLDING TO ENTER CONFIG MODE". After a few more seconds, the introduction screen will appear and the knob can be released. You will now see the CONFIGURE MENU. (Figure 4.27)

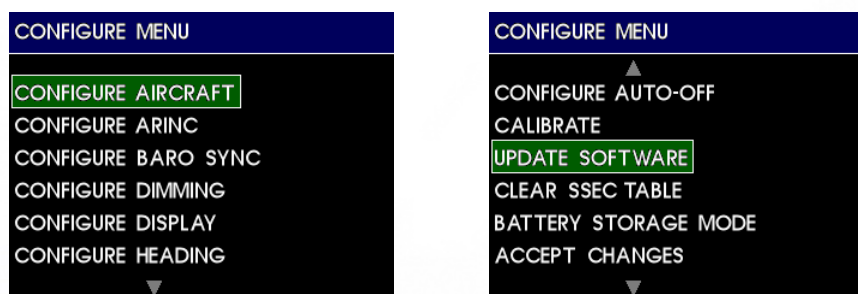

Figure 4.27
CONFIGURE MENU

The CONFIGURE MENU root menu includes the following:

- CONFIGURE AIRCRAFT
- CONFIGURE ARINC
- CONFIGURE BARO SYNC
- CONFIGURE DIMMING
- CONFIGURE DISPLAY
- CONFIGURE HEADING
- CONFIGURE AUTO-OFF
- CALIBRATE
- UPDATE SOFTWARE
- ACCEPT CHANGES
- CANCEL CHANGES

The sub-menu title at the top of the screen displays an indication (>) if there is a parent menu associated with it; see Section 0 for more details regarding menu operation.

NOTE: In Configuration Mode, unlike in the Options Menu, any changes made to any settings will not be saved until you select ACCEPT CHANGES prior to exiting the Configuration Mode.

4.5.1.1 Configure Preview

Where applicable, in Configuration Mode a preview screen is available to assist in visualizing the various selectable settings.

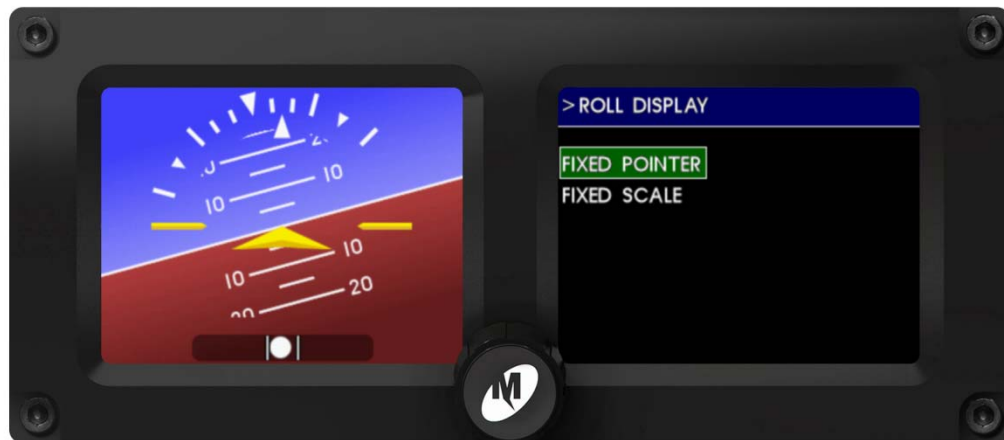

Figure 4.28
CONFIGURE PREVIEW

4.5.2 CONFIGURE AIRCRAFT

The CONFIGURE AIRCRAFT menu option is selected, the sub-menu and its various options are displayed. Note the sub-menu title at the top of the screen and indication (>) that there is a parent menu associated with it. The CONFIGURE AIRCRAFT will return the user back to the CONFIGURE MENU. (Figure 4.29)

Within the CONFIGURE AIRCRAFT sub-menu are the following options:

- PANEL TILT
- PANEL ROLL
- RANGE MMO
- RANGE MARKINGS
- VNE TABLE
- EXIT

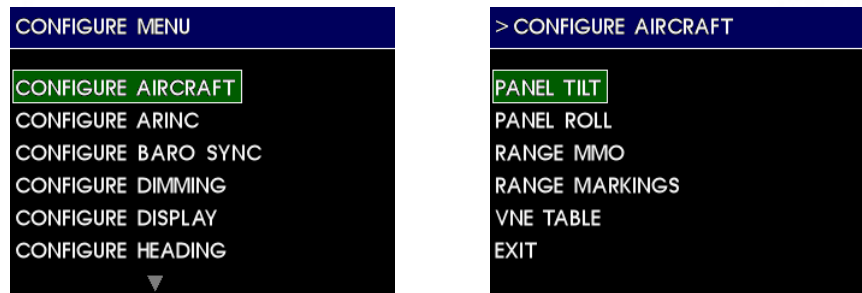

Figure 4.29
CONFIGURE AIRCRAFT

4.5.2.1 Panel Tilt

The PANEL TILT setting allows the installer to input the angle of the instrument panel from -90° to +90° (see Figure 2.1), so that the attitude indicator will show zero pitch when in level flight. Use the control knob to change the value of each panel tilt digit and press the control knob to acknowledge each selection and advance to the next one. (Figure 4.30)

NOTE: To measure and input the panel tilt angle accurately for proper operation the panel tilt should be measured using a digital level or equivalent within $\pm 0.5^\circ$ when in level flight or as simulated on the ground. See the unit specifications for the total range of acceptable panel tilt angles.

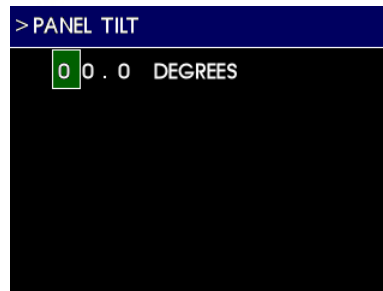

Figure 4.30
PANEL TILT

4.5.2.2 Panel Roll

The PANEL ROLL setting allows the installer to correct for any minor deviations in the actual physical installation if it was not installed precisely straight and level. This feature provides adjustments from -5° to +5° in half-degree increments. This accommodates any noticeable difference between the symbolic airplane and the horizon line when flying straight and level. Use the control knob to change the value of each panel roll digit and press the control knob to acknowledge each selection and advance to the next one. (Figure 4.31)

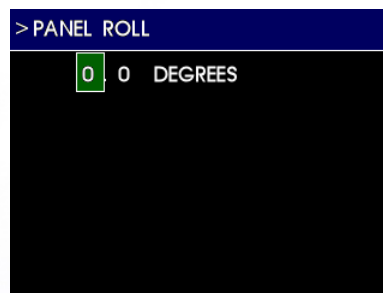

Figure 4.31
PANEL ROLL

4.5.2.3 Range MMO

The RANGE MMO setting allows the installer to input the maximum operating Mach number specific to the aircraft. This is represented by a moving “barber pole” (red and white striped) color bar to the left of the airspeed tape that adjusts with varying airspeed and altitude.

NOTE: THIS ONLY APPLIES TO AIRCRAFT WHICH PUBLISH A MAXIMUM OPERATING MACH NUMBER. The value should be zero for those aircraft which do not publish a maximum operating Mach number (M_{MO}). Use the control knob to change the value of each digit and press the control knob to acknowledge each selection and advance to the next one. (Figure 4.32)

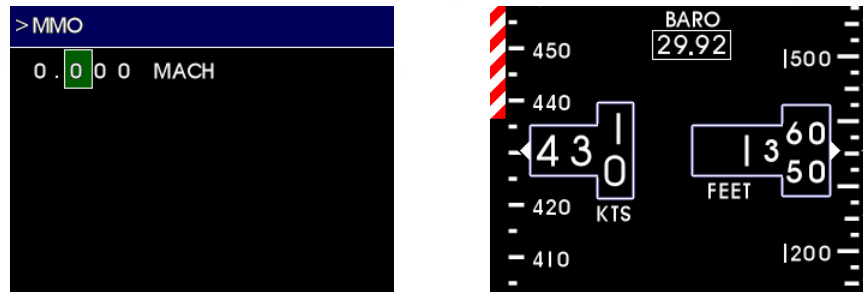

Figure 4.32
MMO ENTRY PAGE AND SAMPLE SCREEN

4.5.2.4 Range Markings

The RANGE MARKINGS setting allows the installer to input airspeed limits (or “V-speeds”) specific to the aircraft. Aircraft airspeed limits can typically be found in the Pilot’s Operating Handbook (POH). The range markings for airspeed limits appear as a series of colored bars to the left of the airspeed tape.

To program range markings: (see Figure 4.33 for examples)

- 1) Use the control knob to select the type of the color bar (HALF, FULL or RAD (radial)).
- 2) Use the control knob to select the desired color (blue, green, red, white, yellow, or BAR (barber pole)).
- 3) Press the control knob to accept the selection and move to the range values.
- 4) Turn the control knob to select each digit and press to move to the next digit.
 - a. The first three digits are the start or lower limit of the color bar range and the second three digits are the upper limit.
 - b. If RAD (radial) is selected, the V1 and V2 will default to the same value.
 - c. Selecting MAX in the V2 column (by entering 999) will extend the bar to the top of the scale.
 - d. Choosing a FULL, BAR (barber pole) type will automatically default V2 to MAX.
 - e. The values automatically represent the units (knots, mph, kph) selected in the CONFIGURE DISPLAY > AIRSPEED UNITS menu.
- 5) Continue in sequence until reaching the EXIT prompt and press the control knob to exit the menu.
 - a. Leaving or selecting “000” for the lower and upper limit creates no color bar.

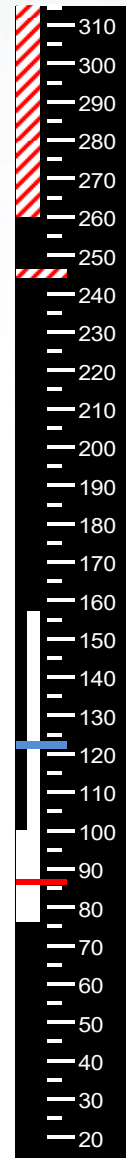
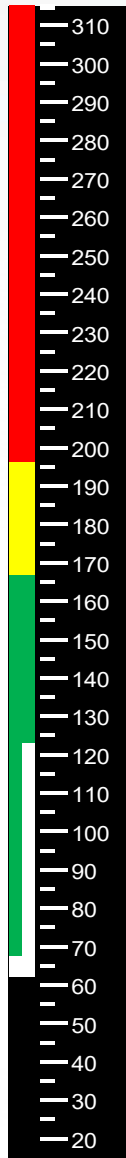

#	TYPE	CLR	V1	V2
1	FULL	WHT	062	068
2	HALF	WHT	068	123
3	FULL	GRN	068	167
4	FULL	YEL	167	196
5	FULL	RED	196	MAX
6	OFF	WHT	000	000
7	OFF	WHT	000	000
8	OFF	WHT	000	000

EXIT

#	TYPE	CLR	V1	V2
1	FULL	WHT	076	100
2	HALF	WHT	100	157
3	RAD	RED	086	086
4	RAD	BLU	122	122
5	RAD	BAR	245	245
6	FULL	BAR	260	MAX
7	OFF	WHT	000	000
8	OFF	WHT	000	000

EXIT

Figure 4.33
RANGE MARKING EXAMPLES

4.5.2.5 VNE Table

The VNE TABLE setting provides the ability to automatically adjust the maximum, or “never exceed”, indicated airspeed (Vne) of the aircraft as a function of altitude. The maximum allowable airspeed is indicated by a barber pole displayed on the range markings to the left of the airspeed tape. If the BAR option is configured in the RANGE MARKINGS settings or the MMO setting is configured, the lowest calculated airspeed between the three settings (including Vne), will be displayed for any particular current altitude.

Data points are entered as (altitude, airspeed) pairs which define the graph for the VNE. The first data point is always at 00000 feet. Any altitudes below zero feet will display the airspeed associated with zero feet. The all other points define lines on the curve. Values between points are interpolated linearly. The last line segment is interpolated indefinitely. (Figure 4.34)

The altitude units are always in feet. The airspeed units, displayed at the top of the column, match the configuration as defined by the AIRSPEED UNITS setting (see Section 4.5.6.1)

> VNE TABLE

#	ALT (FT)	KTS
1	00000	250
2	18000	250
3	18000	230
4	18001	230
5	UNUSED	000
6	UNUSED	000
7	UNUSED	000

EXIT

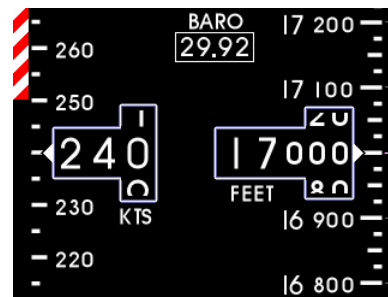

VNE CASE 1

> VNE TABLE

#	ALT (FT)	KTS
1	00000	250
2	12000	250
3	17000	230
4	UNUSED	000
5	UNUSED	000
6	UNUSED	000
7	UNUSED	000

EXIT

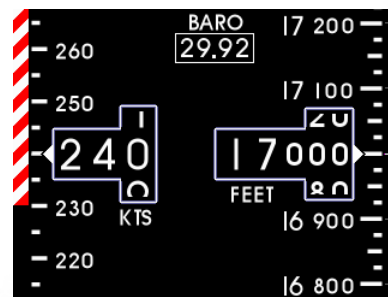

VNE CASE 2

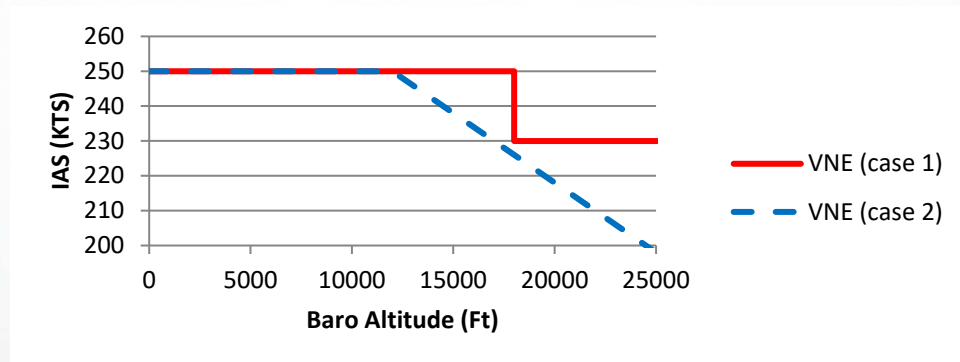

Figure 4.34
VNE CURVE EXAMPLES

4.5.3 CONFIGURE ARINC

The CONFIGURE ARINC action presents two setting options associated with the ARINC 429 data receive and transmit functions. (Figure 4.35)

The PASS-THROUGH option, when set to ON, allows ARINC data provided to the unit from an external source to be combined with the ARINC data generated by the MD302 and transmitted together on the ARINC output pins. If the unit receives the same ARINC label that is also generated by the unit (see Section 1.3.5 for ARINC output labels), the unit will output the MD302-generated data and not pass the received data through to the output. Note that the unit provides ARINC labels associated with Equipment ID 038. If ARINC data is received as a different Equipment ID, it will be associated with ID 038 and the data for that label may not be interpreted properly by other equipment.

The TRANSMIT SPEED option configures the unit's ability to output ARINC 429 communication data as either LOW or HIGH speed serial communication. Refer to Section 1.3 for the list of high and low speed data available. Select the option which corresponds to the receiving equipment's capability in regards to data speed expectation.

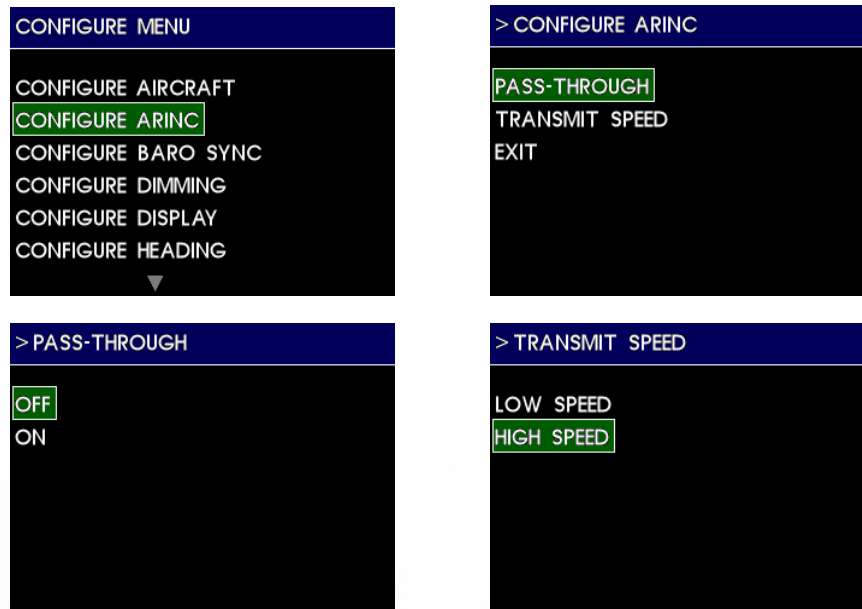

Figure 4.35
CONFIGURE ARINC

4.5.4 CONFIGURE BARO SYNC

The CONFIGURE BARO SYNC action enables or disables baro synchronization via external ARINC input. (Figure 4.36)

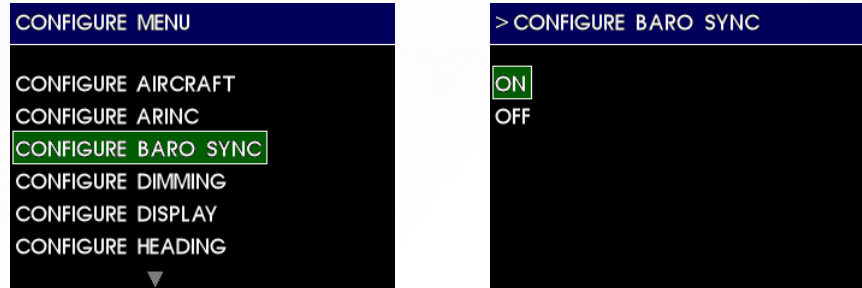

Figure 4.36
CONFIGURE BARO SYNC

4.5.5 CONFIGURE DIMMING

When the CONFIGURE DIMMING menu option is selected, the sub-menu and its various options are displayed. The EXIT selection will return the user back to the CONFIGURE MENU. (Figure 4.37)

Within the CONFIGURE DIMMING sub-menu are the following options:

- DIMMING CONTROL
- DIMMING CURVE
- EXIT



Figure 4.37
CONFIGURE

4.5.5.1 Dimming Control

The DIMMING CONTROL setting allows the installer to select the source of dimming control. It can be an external source, typically the aircraft's adjustable lighting bus, or it can use the INTERNAL photocell built into the unit which senses the ambient light conditions and adjusts the display brightness/dimming automatically. If an external source is to be used, the EXT 5V, EXT 14V, and EXT 28V options represent the input voltage range the unit will accept (0-5VDC, 0-14VDC, and 0-28VDC, respectively). This feature is provided for maximum installation flexibility and control for the pilot. (Figure 4.38)



Figure 4.38
DIMMING CONTROL

4.5.5.2 Dimming Curve

The DIMMING CURVE feature allows the installer to customize the response to the DIMMING CONTROL input, whether internal or external, over its range of operation. Therefore, for various points throughout the input range, the brightness can be adjusted up or down to produce a unique dimming scheme that most closely matches the other instruments in the panel and the pilot’s preferences. This feature is provided for maximum installation flexibility and control for the pilot.

NOTE: When new, the display is daylight-visible at approximately 75% brightness. It may not be necessary to set the dimming curve to 100%. Setting the high-brightness side of the dimming curve to less than 100% will extend the life of the LED backlight and provide margin for the pilot to increase brightness as desired.

When setting the dimming curve with the dimming control set to INTERNAL, the X-axis of the dimming graph will read AMBIENT and will range from MIN to MAX. This represents the brightness of the light the unit’s photocell can see and shows the current ambient light level with the vertical blue line. The Y-axis represents brightness of the display. It will track the dimming curve with the horizontal blue line as the input light increases or decreases. The best method for setting the dimming curve is to simulate the range of lighting conditions. This is best done after installation, in the actual aircraft instrument panel, but can be simulated in various environments. (Figure 4.39)

- 1) Change the light of the cockpit or general area around the unit until the vertical blue line matches (or nearly matches) the yellow highlighted point on the graph.
- 2) Adjust the control knob to increase or decrease the brightness of the display to the desired level at that lighting condition (the point will move up or down, respectively).
- 3) When satisfied, press the control knob.
- 4) The next point will be highlighted.
- 5) Repeat Steps 1-4 for each point on the graph

When setting the dimming curve with the dimming control set to external input (EXT 5V/EXT 14V/ EXT 28V), the X-axis of the dimming graph will read VOLTS and will range from 0 to 5, 14 or 28. This represents the voltage input of the lighting bus and shows the current input with the vertical blue line. The Y-axis represents brightness of the display. It will track the

dimming curve with the horizontal blue line as the input voltage increases or decreases. When an external lighting input is selected, a 'low-level auto-adjust' feature is added which is represented by a vertical white line on the dimming curve graph. When the input lighting voltage is below this level, the unit will automatically adjust the brightness based on the ambient light condition sensed by the photocell. This provides more accurate lighting output when the lighting voltage is turned down or off.

The best method for setting the dimming curve is to simulate the range of lighting inputs or conditions to match other instruments. This is best done after installation, in the actual aircraft instrument panel, but can be simulated in various environments. (Figure 4.40)

- 1) Change the lighting bus input until the vertical blue line matches (or nearly matches) the yellow highlighted point on the graph.
- 2) Adjust the control knob to increase or decrease the brightness of the display to the desired level at that lighting bus position (the point will move up or down, respectively).
- 3) When satisfied, press the control knob.
- 4) The next point will be highlighted.
- 5) Repeat Steps 1-4 for each point on the sloped line of the graph.
- 6) If set to external input, a final highlighted point will be available on a vertical white line.

As the lighting input voltage is turned down or off, setting this threshold determines when the unit reverts to automatic brightness control (via photocell). Adjust this dot horizontally with the control knob to set the low-input level of the lighting bus where the default brightness takes effect. You can verify where this occurs by adjusting the lighting bus input. Press the control knob to accept the position chosen. If this point is set to zero (far left), the brightness will only revert to automatic photocell control when the lighting bus is turned off or fails open.

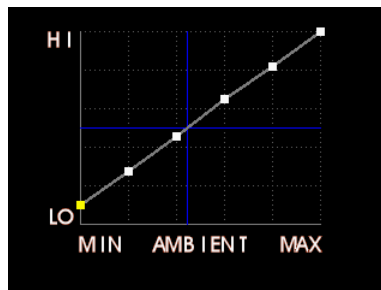

Figure 4.39
INTERNAL (PHOTOCELL) DIMMING CURVE

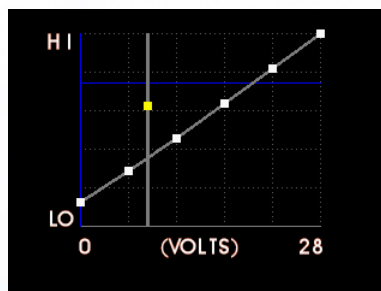

Figure 4.40
EXTERNAL INPUT DIMMING CURVE

4.5.6 CONFIGURE DISPLAY

When the CONFIGURE DISPLAY menu option is selected, the sub-menu and its various options are displayed. Note the sub-menu title at the top of the screen and indication (>) that there is a parent menu associated with it. Selecting the EXIT CONFIG DISPLAY will return the user back to the CONFIGURE MENU. (Figure 4.41)

Within the CONFIGURE DISPLAY sub-menu are the following options:

- ROLL DISPLAY
- AIRSPEED UNITS
- AIRSPEED MINIMUM
- DISPLAY ORIENTATION
- HORIZON DISPLAY
- EXIT

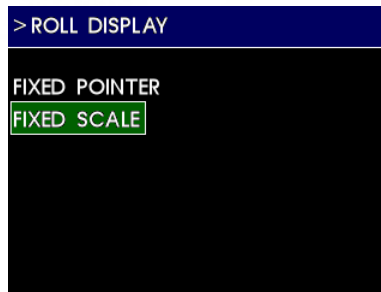

Figure 4.41
CONFIGURE DISPLAY



4.5.6.1 Roll Display

The ROLL DISPLAY setting allows the installer to select either the FIXED POINTER or FIXED SCALE option. The FIXED POINTER option makes the lower triangle pointer always point to the top of the display to represent the aircraft's position in relation to the scale. The roll scale containing the radial grads and triangles on the attitude display will rotate with the horizon. The FIXED SCALE option (also known as 'sky pointer') sets the roll scale stationary and allows the lower triangle pointer to rotate with the horizon. This feature should be selected to match other attitude instrument representations in the panel for consistency. (Figure 4.42)



FIXED POINTER

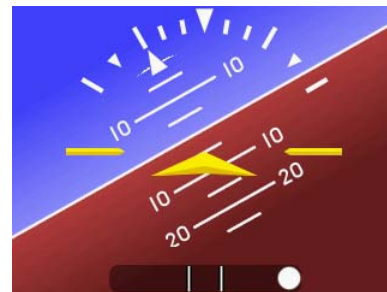

FIXED SCALE

Figure 4.42
ROLL DISPLAY

4.5.6.1 Airspeed Units

The AIRSPEED UNITS setting allows the installer to select the airspeed units to KNOTS, MPH (miles per hour) or KPH (kilometers per hour). The default setting is KNOTS. This feature should be selected to match the other airspeed instrument displays in the panel for consistency and reduced fatigue/work load on the pilot when switching field-of-view between instruments. (Figure 4.43)



Figure 4.43
AIRSPEED UNITS

4.5.6.2 Airspeed Minimum

The AIRSPEED MINIMUM setting allows the installer to select the lowest airspeed which will be displayed above zero (0). This feature allows the unit to be configured similarly to other airspeed displays in the panel and/or for mission-specific applications. At speeds below this minimum, the unit will display zero (0). The options are 20 KTS, 30 KTS or 40 KTS. The default setting is 30 KTS. If MPH or KPH airspeed units are selected, the airspeed minimum will be calculated that equates to the KTS value selected on this screen. (Figure 4.44)



Figure 4.44
AIRSPEED MINIMUM

4.5.6.3 Display Orientation

The DISPLAY ORIENTATION setting allows the installer to select how the unit will be oriented in the panel. It can be installed HORIZONTAL, VERTICAL RIGHT, VERTICAL LEFT, or HORIZONTAL (SWAP). In the HORIZONTAL orientation, the attitude display defaults to the left display and the unit must be installed with the control knob at the bottom of the unit. The HORIZONTAL (SWAP) positions the attitude display on the right display. In the VERTICAL RIGHT orientation, the control knob is located on the right side of the unit. In the VERTICAL LEFT orientation, the control knob is located on the left side of the unit. See Section 2.1 Equipment Location when determining where and how to orient the unit in the aircraft instrument panel. This feature is provided for maximum installation flexibility but should be chosen carefully to fully comply with regulatory requirements to minimize visual scan and allow for easy access. NOTE: in the vertical orientation, the location of the knob should be selected so that the pilot does not obstruct the display when operating the control knob. (Figure 4.45)

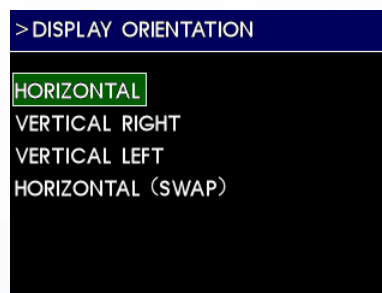
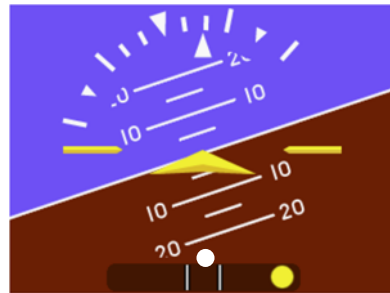
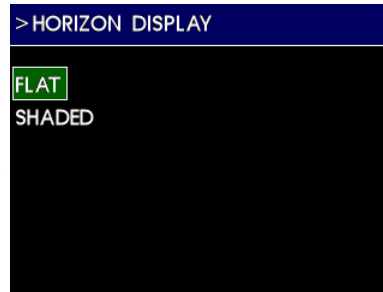

Figure 4.45
DISPLAY ORIENTATION



4.5.6.4 Horizon Display

The HORIZON DISPLAY setting allows the installer to select the visual effect of the horizon background. The FLAT option provides a solid blue-over-brown color scheme. The SHADED option provides a gradated blue-over-brown that lightens closer to the horizon line and darkens towards the edges of the display. (Figure 4.46)



FLAT HORIZON BACKGROUND



SHADED HORIZON BACKGROUND

Figure 4.46
HORIZON DISPLAY

4.5.7 CONFIGURE HEADING

The CONFIGURE HEADING feature selects whether the heading is displayed or not. If configured to display heading, the MD302 needs to have the MD32 Remote Magnetometer installed or external ARINC 429 input data provided with labels 014 or 320 (see Section 4.3.1.2). (Figure 4.47)

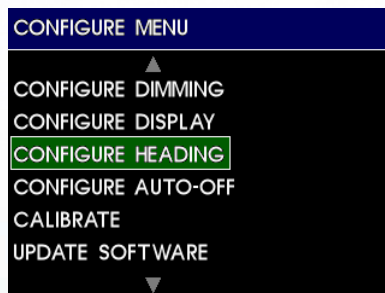

Figure 4.47
HEADING DISPLAY

4.5.8 CONFIGURE AUTO-OFF

The AUTO-OFF action enables or disables the unit from automatically shutting off battery power following 60 seconds of being on the ground. See section 4.4.2 for more detail. (Figure 4.48)

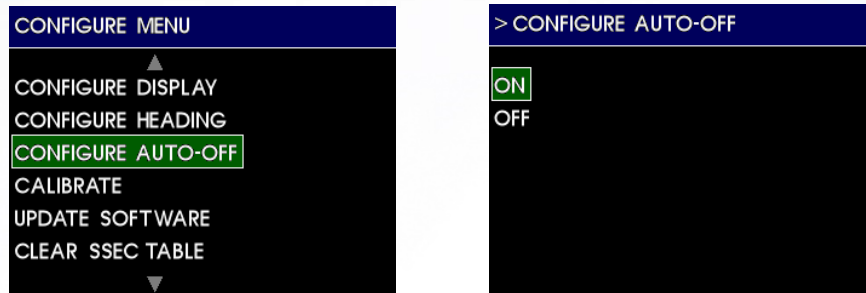

Figure 4.48
CONFIGURE AUTO-OFF

4.5.9 CALIBRATE

The CALIBRATE menu provides access to calibration of the airspeed and altitude functions, as well as on-aircraft calibration of the MD32 remote magnetometer. (Figure 4.49)

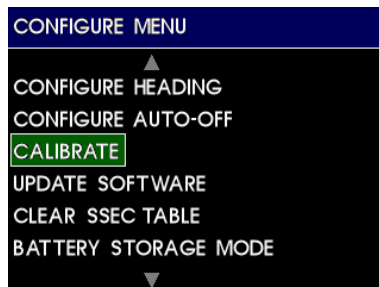

Figure 4.49
CALIBRATE

4.5.9.1 Calibrate Airspeed

The CALIBRATE AIRSPEED function provides a method to compensate for offsets that may develop in the sensors over time. An external pitot port tester is required (such as Laversab 6200, 6300, 6500, or the 6600 series or equivalent). The tester must be attached to the MD302 pitot port and stabilized to 120 knots. (Figure 4.50)

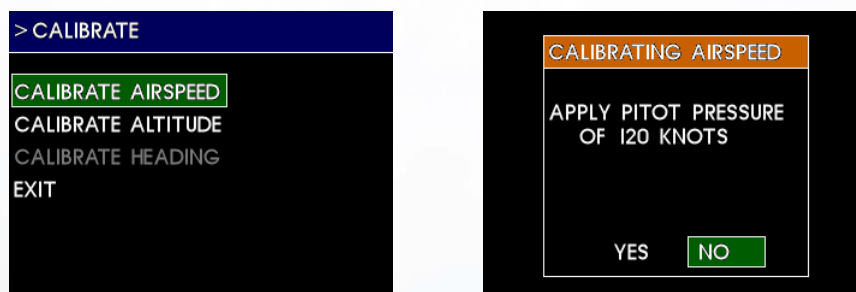

Figure 4.50
CALIBRATE AIRSPEED

4.5.9.2 Calibrate Altitude

The CALIBRATE ALTITUDE function provides a method to compensate for offsets that may develop in the sensors over time. An external static port tester is required (such as Laversab 6200, 6300, 6500, or the 6600 series or equivalent). The tester must be attached to the MD302 static port and stabilized to 5,000 feet. (Figure 4.51)



Figure 4.51
CALIBRATE ALTITUDE



IMPORTANT: AFTER CALIBRATING PRESSURE, THE AIRSPEED AND ALTITUDE FUNCTIONS MUST BE TESTED FOR THE REQUIRED TOLERANCES ACROSS THE OPERATING RANGE OF THE AIRCRAFT.

4.5.9.3 Calibrate Heading

After installation of a MD32 Remote Magnetometer, on-aircraft calibration must be performed to calculate the alignment and remove the aircraft effects on the magnetometer. (Figure 4.52) See the MD32 Installation Manual (9019050) for instructions on mounting and wiring.

NOTE: Calibration must also be performed if the MD302 or MD32 is replaced.

NOTE: Please read all of this section prior to starting the heading calibration process.

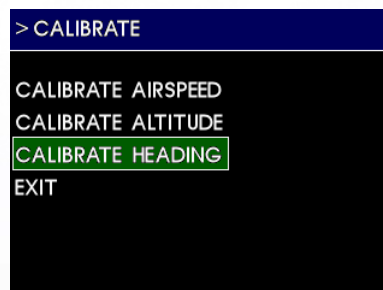

Figure 4.52
CALIBRATE HEADING

PREPARATION

The following should be considered prior to performing heading calibration:

- The MD32 should be installed in a magnetically quiet location, away from any ferrous materials.
- The MD32 must be permanently installed and connected to the MD302 with power on. The CALIBRATE HEADING menu item will not be selectable if the MD32 is not properly communicating with the MD302.
- All aircraft equipment should be powered up and functioning prior to starting the heading calibration.
- An accurate heading reference for headings 360, 090, 180, and 270 is required. An airport compass rose is recommended.
- A flat and level surface should be used during the heading calibration.
- Any magnetic noise sources should be kept away from the aircraft during the calibration procedure.
- The aircraft should be held as stationary and level as possible during the calibration procedure.

PROCEDURE

1. Start the MD302 in configuration mode. (Press and hold the control knob while applying power to the unit)
2. Navigate to the CALIBRATE menu and select the CALIBRATE HEADING menu item.
3. Verify all avionics are powered and stable and start the aircraft engine.
4. Follow the on-screen instructions to complete the calibration procedure. A few notes on the calibration instructions:
 - a. The MD302 will request the inclination angle (in degrees) at your current location. (Figure 4.53) This can be measured using appropriate equipment, or can be found by entering your location at the following website:
http://www.geomag.bgs.ac.uk/data_service/models_compass/wmm_calc.html

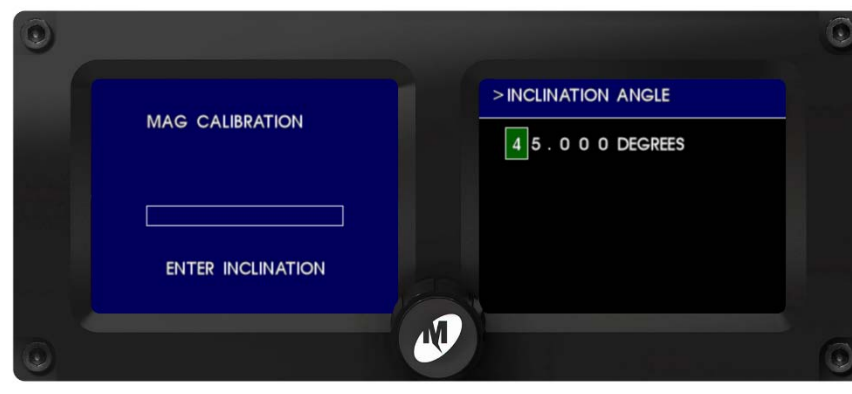

Figure 4.53
INCLINATION ANGLE



- b. The MD302 will request information about your remote magnetometer orientation. Select the option which best describes the mounting orientation of the MD32 remote magnetometer, with the selected axis pointing towards ground. (Figure 4.54 and Figure 4.55)

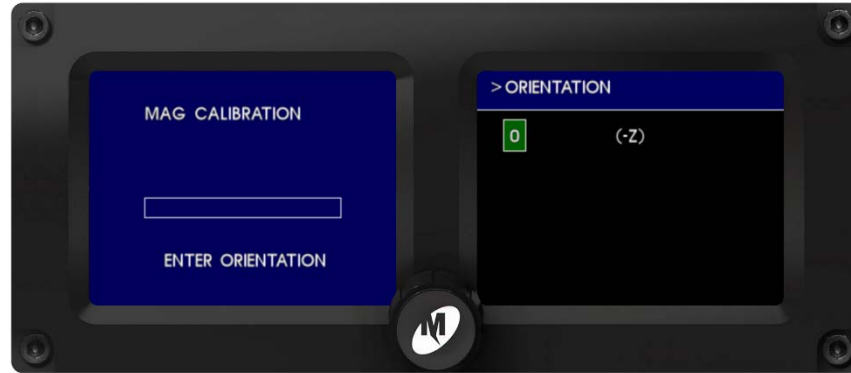

Figure 4.54
ORIENTATION

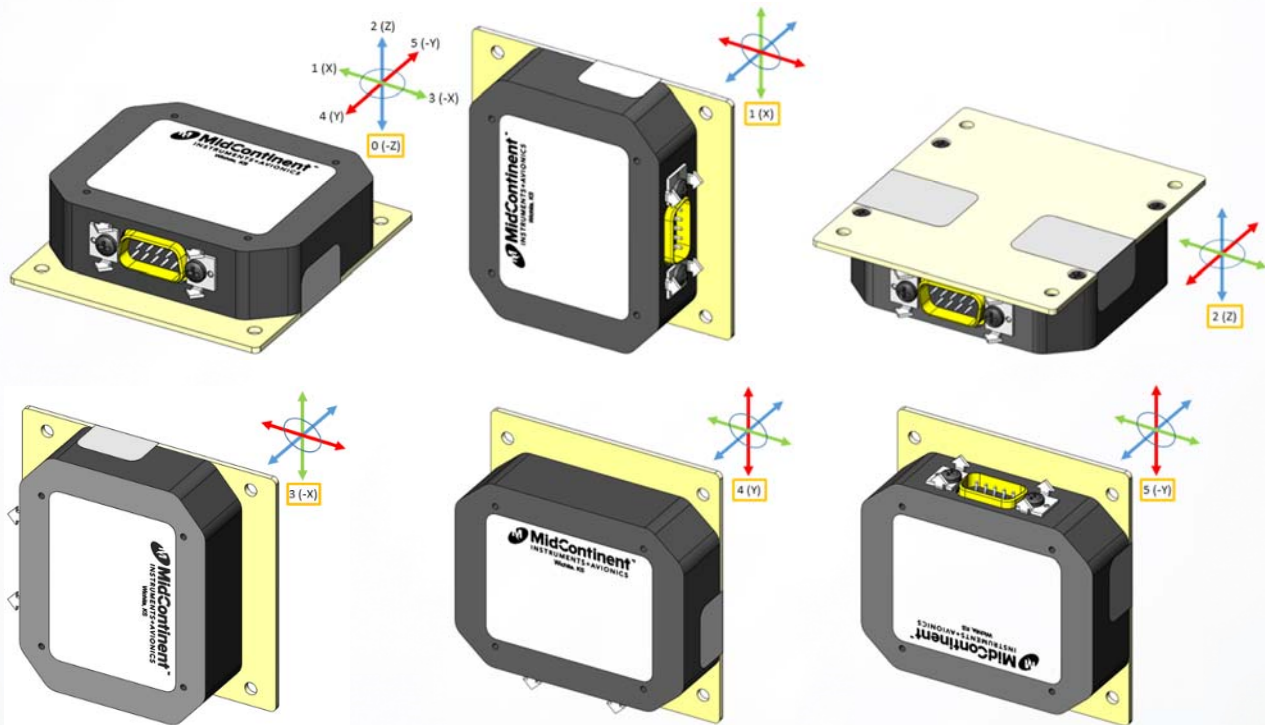

Figure 4.55
MAGNETOMETER INSTALLATION ORIENTATIONS



- c. The MD302 will request the aircraft be aligned to the following headings: 360, 090, 180, and 270. After aligning the aircraft to each heading, wait until the aircraft is fully stopped and stable for 10 seconds before selecting YES. Maintain position without moving the aircraft for the full 60 seconds. (Figure 4.56)

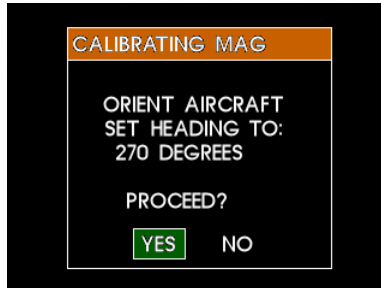

Figure 4.56
CALIBRATING MAG

- 5. After calibration is successful, the yellow dots should line up on each axis. The green dots should be close or entirely covered by the yellow dots. (Figure 4.57)

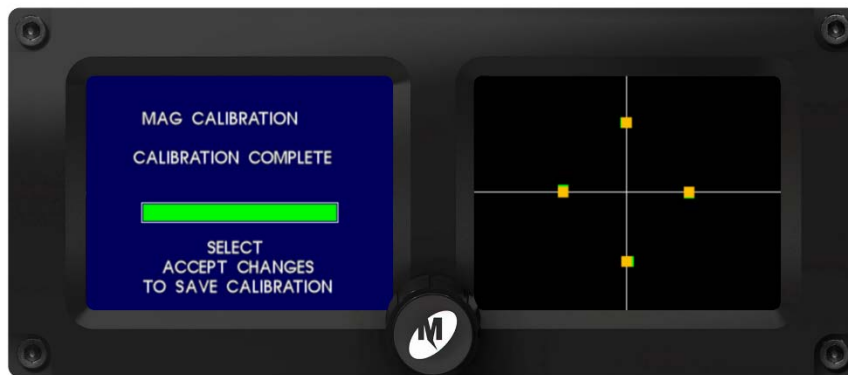

Figure 4.57
CALIBRATION COMPLETE

- 6. Be sure to select ACCEPT CHANGES in the Configuration Menu after the calibration procedure in order to store the calibration results to the MD302. (Figure 4.58)

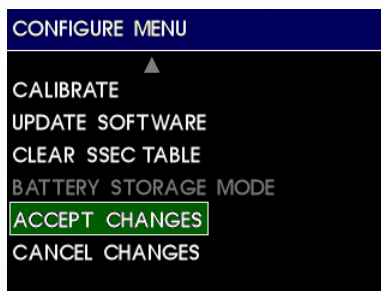
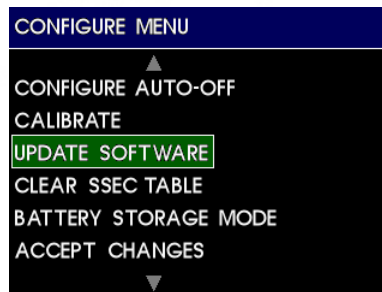

Figure 4.58
ACCEPT CHANGES

4.5.10 UPDATE SOFTWARE

The UPDATE SOFTWARE action initiates a search for software on an installed USB flash drive present in the USB port on the rear of the unit. (Figure 4.59) This action is unavailable in Emergency Mode (on battery power). If a USB device is not detected or a valid software update file is not found, a failure message will appear and return back to the Configuration Menu. If a valid software update file is detected, a software update progress screen will appear. The status screen will indicate when the software update completes successfully. Acknowledging this completion will automatically reset the unit and return to the Pre-flight Mode, followed by entering Flight Mode. See Section 5.1.2 for more information.

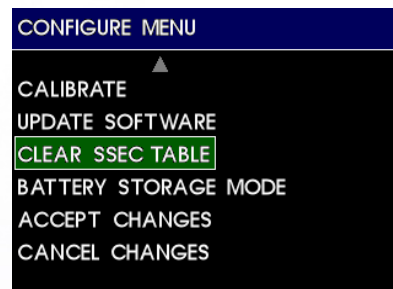

**Figure 4.59
UPDATE SOFTWARE**

4.5.11 STATIC SOURCE ERROR CORRECTION

Static Source Error Correction (SSEC) provides optional air data corrections for both altitude and airspeed based on aircraft-specific structural flight dynamics. When loaded, the installed SSEC data can be verified via identification on the Start-up screen, the REVIEW CFG screen, and/or the ARINC 429 output. The CLEAR SSEC TABLE selection provides a way to remove any previous SSEC configuration data. (Figure 4.60)

Please contact Mid-Continent Instruments and Avionics for further information regarding this feature.



**Figure 4.60
CLEAR SSEC TABLE**

4.5.12 ACCEPT CHANGES

When selecting ACCEPT CHANGES, all settings and changes made while in Configuration Mode are saved into memory and saved to the Configuration Module memory as well. (Figure 4.61)

NOTE: SETTINGS WILL NOT BE SAVED UNLESS “ACCEPT CHANGES” IS SELECTED WHEN DONE.

After selecting ACCEPT CHANGES, the unit will automatically reset and return to the Pre-flight Mode, followed by entering Flight Mode.

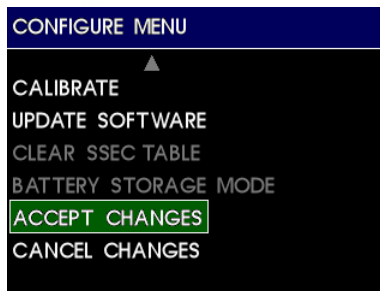

**Figure 4.61
ACCEPT CHANGES**

4.5.13 CANCEL CHANGES

When selecting CANCEL CHANGES, any settings or changes made while in Configuration Mode are canceled. ANY SETTINGS WILL NOT BE SAVED. After selecting CANCEL CHANGES, the unit will automatically reset and return to the Pre-flight Mode, followed by entering Flight Mode. (Figure 4.62)

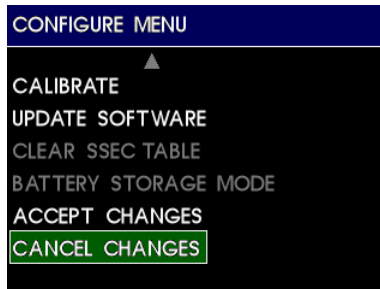

**Figure 4.62
CANCEL CHANGES**

SECTION 5 CONFORMANCE

5.1 INSTRUCTIONS FOR CONTINUED AIRWORTHINESS

5.1.1 Pressure System and Altimeter Verification

Per federal regulation 14 CFR 91.411, it is required that each static pressure system and each altimeter have been tested and inspected within the last twenty-four (24) months. See Section 4.6 to calibrate pressures, should pressures be out of calibration per 14 CFR 91.411.

5.1.2 Software Updates

Mid-Continent will have, on occasion, the need to update the software of the MD302 to maintain, improve and/or enhance functionality or performance.

With the MD302's easy field-upgrade option, the unit does not have to be returned to the factory, and in some cases, may not have to be removed from the panel.

Software updates are typically communicated to the public via Service Bulletins issued by Mid-Continent Instruments and Avionics and can be found on the product website, www.flySAM.com. Below are instructions for updating the unit software.

Please read through all instructions before beginning.

PREPARATION

1. Prepare software update file.
 - a. Download the approved software file to the root directory of a standard FAT-formatted USB flash drive from **www.flySAM.com/software-updates**. The downloaded file must retain the exact file name.
2. Ensure that the unit is powered off.
3. Remove the unit from the instrument panel.
 - a. Remove the four mounting screws attaching the bezel of the unit to the panel.
 - b. Pull the unit forward until the end plate is accessible.

NOTE: This can be done without removing the electrical connector or pneumatic connections if the proper service lengths were applied during installation.
4. Loosen the screw of the USB access cover on the rear of the unit until the USB port is accessible.

LOAD SOFTWARE

5. Insert the USB flash drive with the approved software file into the USB port.
6. Press and hold the Control Knob on the faceplate while applying external power to the unit. (Software updates cannot be performed using internal battery power.)
7. Continue holding as prompted (up to 10 seconds) until the Pre-Flight Screen appears. Once CONFIGURE MENU is displayed, the unit is in Configuration Mode.
8. Turn the Control Knob to highlight the UPDATE SOFTWARE option. External power must be applied to complete this step.
9. Press the Control Knob to initiate the software load.

If the software update is unsuccessful, a message will display FAILED UPDATE. Should this occur, remove the USB flash drive, power down the unit and return to Step 5 of the Service Action above. If the error message persists, contact Mid-Continent Instruments and Avionics.

10. When the software load is complete, the unit will display SUCCESSFUL UPDATE. Press the Control Knob to confirm.
11. The unit will reboot into Flight Mode.
12. To verify proper software load, confirm that the new software version number is displayed on the Pre-Flight Screen during unit startup.

RETURN TO SERVICE

13. Remove the USB flash drive.
14. Close the USB Access Cover and tighten the screw in place.
15. Re-install the unit into the instrument panel in reverse order as described in Step 3 (above).

**If loading an SSEC configuration file, repeat above steps 1 through 15 using a USB flash drive with only an SSEC configuration file loaded.*

5.1.3 Battery Replacement

Scheduled maintenance of the internal battery is not required. The battery will recharge itself from aircraft power while in normal mode. A battery capacity check occurs each time the unit is powered on. If the battery can provide more than 60 minutes of backup power, no message is displayed and the battery is good.

If a unit has a battery pack warning, and the warning persists over subsequent dispatches, it should be replaced. If the battery pack requires replacement, please contact Mid-Continent Instruments and Avionics to order (see Section 2.2 for associated part number).

Field replacement requires minimal effort and is achieved by removing two small screws on the rear of the unit, removing the battery cover, and pulling the battery out using the handle/strain relief built on the battery. Replace the battery with the new battery and verify operation. See figure below.

It is recommended to replace the battery with the same battery part number/Type (1 or 2). However, either battery Type will function in all battery units. Verify your installation certification requirements prior to changing from one battery Type to another.

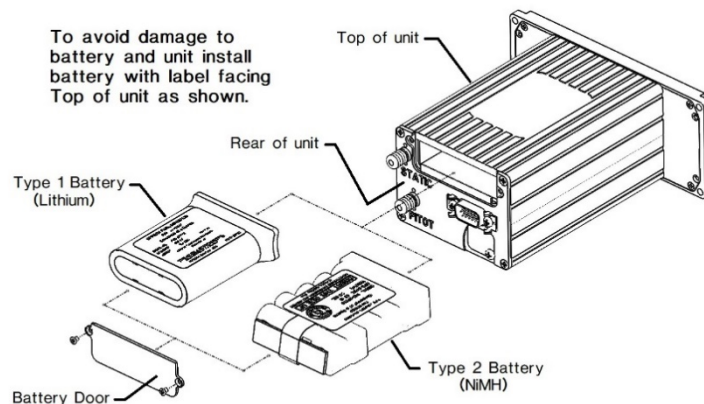

BATTERY REPLACEMENT

5.1.4 Troubleshooting

The following Figures and associated descriptions represent warnings or errors and describe the typical reasons and appropriate response action.



FIGURE 5.1

The attitude display has failed due to exceedance of internal rate sensors, loss of airspeed or other various reasons. This will typically self-correct. However, if it does not, immediately have the unit serviced.

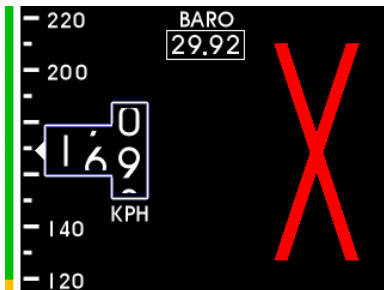

FIGURE 5.2

The altimeter instrument has failed, possibly due to exceedance of the pressure sensor range. This may self-correct, but if the error persists, immediately have the unit serviced.

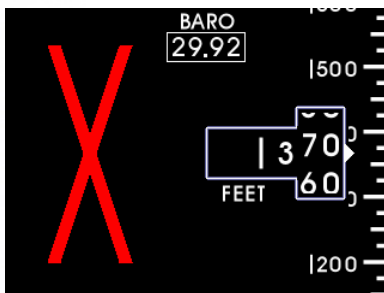

FIGURE 5.3

The airspeed instrument has failed, possibly due to exceedance of the pressure sensor range. This may self-correct, but if the error persists, immediately have the unit serviced.

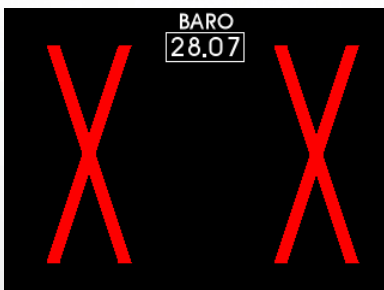

FIGURE 5.4

The airspeed and altimeter display have both failed due to exceedance of their respective sensor ranges. This may self-correct, but if the error persists, service unit immediately.

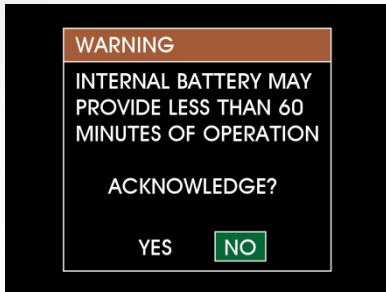

FIGURE 5.5

Battery failed initial capacity check. This may be due to recent battery usage without allowing time to recharge. This may also occur during extreme temperature conditions. User may acknowledge this error and continue operation, but available backup power capacity may be less than required minimum levels. If this warning persists, the battery will need serviced.

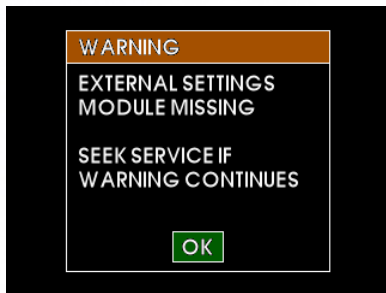

FIGURE 5.6

The configuration module has failed or is not installed properly. Internal settings will be used. If the configuration module is installed, it should be serviced immediately.



FIGURE 5.7

Internal failure. Service unit immediately.

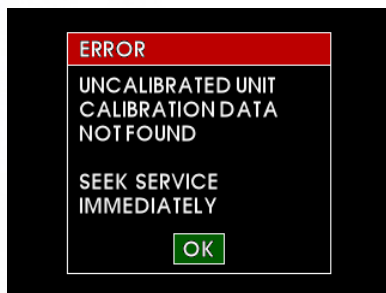

FIGURE 5.9

Internal failure. Service unit immediately.

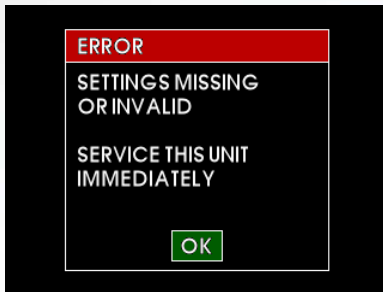

FIGURE 5.10

Internal (unit) and external settings (configuration module) failure. It is unlikely that both settings would be lost. Try to reconfigure the unit. Service unit if this error persists.

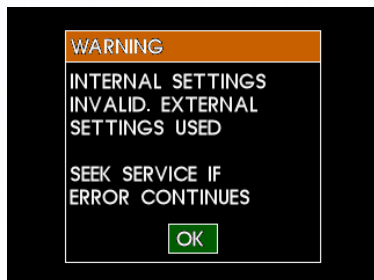

FIGURE 5.11

Internal (unit) settings were found to be invalid. The configuration module settings will be copied to internal memory. Service unit if this error persists.



FIGURE 5.12

External settings (configuration module) were found to be invalid. The internal settings will be copied to the configuration module memory. Service unit if this error persists.



FIGURE 5.13

Internal (unit) and external (configuration module) settings were found to be different. This is typically the result of replacing a unit in an existing installation. The external settings will be copied to replace the settings in internal memory.

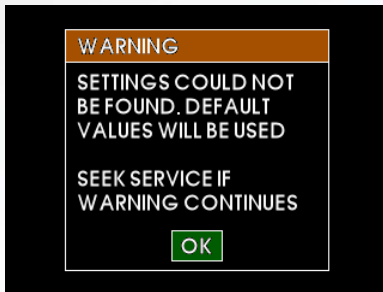

FIGURE 5.14

In configuration mode, this may be the result of lost settings both internally and externally. Try to configure the unit. Seek service if error persists.

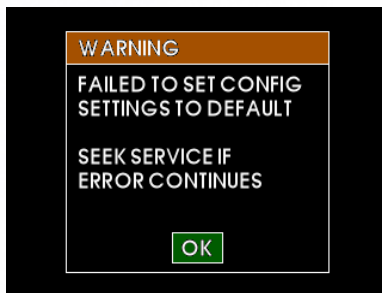

FIGURE 5.15

In configuration mode, this may be the result of lost settings and a failure to initialize memory. Try to restart and configure the unit. Seek service if error persists.



FIGURE 5.16

Internal (unit) and external (configuration module) settings were found to be different. This is typically the result of replacing a unit in an existing installation. In configuration mode, this choice allows selection of which settings to use.



FIGURE 5.17

The internal battery is experiencing over temperature condition and needs to be serviced immediately. If the unit is operating on external power, select “OK”, the unit will continue to operate and the battery icon will change to a black battery with a red X on it, see Figure 3.23. If the unit is operating on standby power, the unit will shut off immediately.

5.2 ENVIRONMENTAL QUALIFICATION STATEMENT

MODEL NUMBER: MD302 Series **PART NUMBER:** 6420302-()
DESCRIPTION: 2-inch Standby Attitude Module (SAM)
CERTIFICATION: FAA TSO-C2d (Type B), C3e, C4c, C6e, C10b, C106, C113a, C179a
MANUFACTURER: Mid-Continent Instrument Co., Inc.
ADDRESS: 9400 E. 34th St. North, Wichita, KS 67226, USA.
SPECIFICATION: Test Specification (TS) 302 Test Data Sheet (TDS) 302
STANDARD: RTCA DO-160, Rev G, dated 12/08/2010

CONDITIONS	SECTION	DESCRIPTION OF TEST
Temperature and Altitude	4	Category B2
Temperature Variation	5	Category S2
Humidity	6	Category A
Operational Shock and Crash Safety	7	Category B
Vibration	8	Fixed Wing: Category R, Curves B, B1 Rotorcraft: Category U, Curve G
Explosion	9	Category X
Waterproofness	10	Category X
Fluids	11	Category X
Sand and Dust	12	Category X
Fungus	13	Category F
Salt Fog	14	Category X
Magnetic Effect	15	Category Z
Power Input	16	Category Z
Voltage Spike	17	Category A
Audio Frequency Conducted Susceptibility	18	Category Z
Induced Signal Susceptibility	19	Category ZC
Radio Frequency Susceptibility	20	Category Y Category G
Emission of Radio Frequency Energy	21	Category P
Lightning Induced Transient Susceptibility	22	Category B3 Category H3L3, K3L3
Lightning Direct Effects	23	Category X
Icing	24	Category X
ESD	25	Category A
Fire, Flammability	26	Category X

REMARKS:

Section 4: Category B2 with excursions as declared by the manufacturer:

- 4.5.1: Ground Survival Low Temp -45°C
- 4.6.1: Altitude +55,000 feet
- 4.6.2: Decompression +8,000 feet
- 4.6.3: Overpressure -15,000 feet